

# Custom Install Product Guide

SPEAKERS & ELECTRONICS



**Interactive PDF**

Click on product images and text to learn more about products and services

# ABOUT MONITOR AUDIO

Monitor Audio Ltd is a British company and global specialist in hi-fi loudspeaker design. For over 40 years we've been incorporating stereo and surround sound systems and a range of sonically matched architectural speakers for ultra discreet high quality sound around the home and outside.

Stereo / Surround sound systems

Custom Install / Architectural speakers



## Monitor Audio Custom Install

By choosing Monitor Audio Custom Install products, you're securing the utterly desirable combination of seamless integration and superior sound quality, backed by decades of design innovation and award success. We distribute to over 80 countries worldwide. Please refer to our website [monitoraudio.com](https://www.monitoraudio.com)

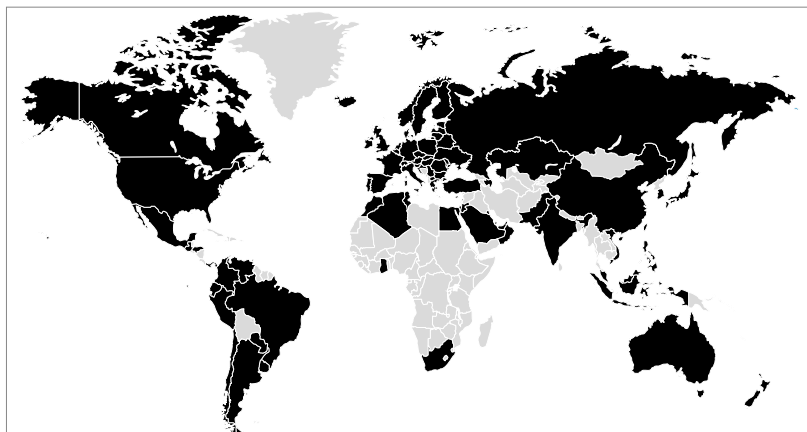

# WHY CHOOSE MONITOR AUDIO CUSTOM INSTALL SOLUTIONS

Monitor Audio's Custom Install products are engineered for high performance, reliability and ease-of-use. They've been developed using the advanced driver technologies of our award-winning hi-fi speaker ranges to deliver world-famous sound quality without compromising room design.

Available across varying performance levels, Monitor Audio's architectural speakers bring innovation to every application – wherever you decide to experience dynamic music and film sound, there's an In-Ceiling or In-Wall speaker that's perfect for the role. The speakers are expertly optimised for rhythmic wideband audio, seamless room integration and easy, secure installation.

If you love your décor and appreciate great audio, you needn't compromise: Monitor Audio's architectural speakers will create harmony all around your home.

## Main features

Audio solution for diverse spaces and applications

Solid and reliable build quality

Quick, easy and more secure install

High quality sound performance

Minimum cut outs

Minimum mounting depths

Magnetic attachment round and square grilles

Vertical or horizontal orientation

Patented Tri-Grip mounting clamps

## Range features

Super Slim and Slim

Back Box solution

Flush Fit





Invisible

Weather Resistant solution

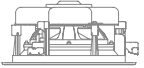

# CONTENTS

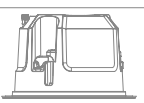
CI Ranges – Click on sections below, to return click on the home button

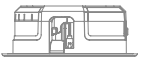
Page		
8	Core (C/W)	 4 <sup>1</sup> / <sub>2</sub> " / 114 mm
12	Slim (CS)	 3 <sup>7</sup> / <sub>8</sub> " / 98.6 mm
13	Super Slim (CSS/WSS)	 2" / 50 mm
14	Controlled Performance (CP)	 5 <sup>15</sup> / <sub>16</sub> " / 151mm
19	Flush Fit (CF)	 3 <sup>5</sup> / <sub>16</sub> " / 83.62 mm
20	Invisible (IV)	Ultimate discretion
22	Platinum II (PL)	Flagship
25	Pro (PRO)	 <b>Commercial</b> 3 <sup>7</sup> / <sub>16</sub> " / 87.7 mm
27	All Weather (AWC)	 <b>Weather Resistant</b> 3 <sup>1</sup> / <sub>2</sub> " / 88.5 mm
28	Climate	Weather Resistant
29	Climate Garden System (CLG)	Weather Resistant garden speakers
30	Custom Subwoofers	
32	Amplifiers	
34	Soundbars (SB)	
36	SoundFrame (SF)	
39	Accessories	
42	Specification tables	

# CUSTOM INSTALL NAMING SYSTEM

Monitor Audio's Custom Install products are named based on their application, technologies, driver sizes and special features.

Example

## C265-IDC

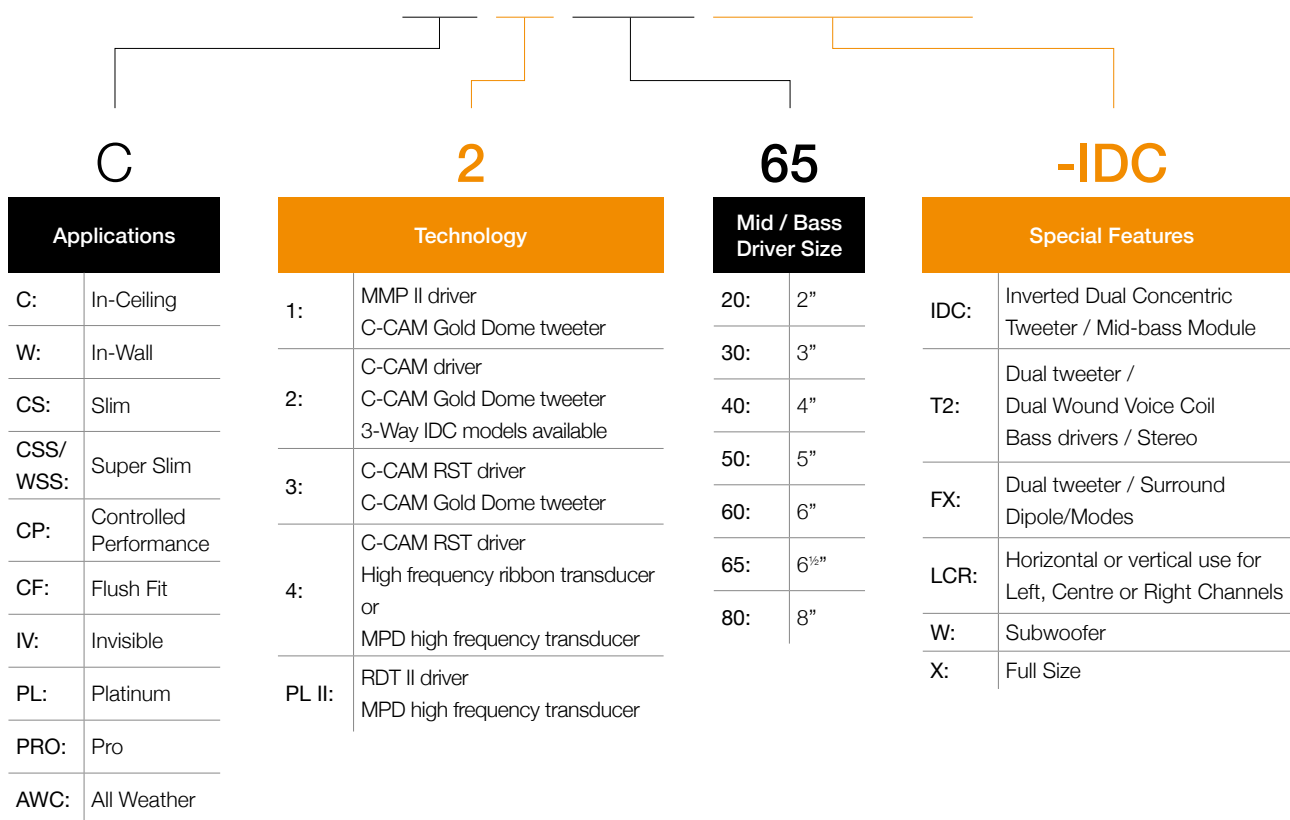

There is explanation of our technology mentioned above on the next page.

# TECHNOLOGY

Below is a brief description of each advanced technology used in our award-winning speakers. To achieve a harmony of space and sound for every possible application, we've created a wide range of options across varying performance levels.

## DRIVERS

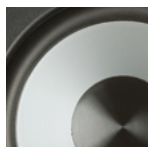

**MMP II Driver:** Metal Matrix Polymer driver cones have a polypropylene base loaded with metallic particles to offer a rigid and responsive structure.

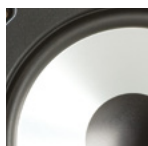

**C-CAM Driver:** Ceramic-Coated Aluminium Magnesium cones have a much higher resistance to bending stress and therefore exhibit much greater fidelity over their entire operating range.

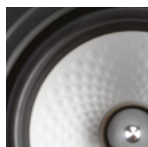

**C-CAM RST Driver:** Rigid Surface Technology cone developed and perfected using sophisticated computer modelling (Finite Element Analysis). The strengthening effect of RST means that we can use thinner, lighter and more responsive C-CAM cones, providing speed and accuracy with reduced distortion.

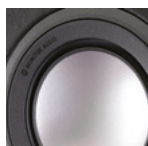

**RDT II Driver:** Rigid Diaphragm Technology 2nd Generation is a composite 'sandwich' structure made from ultra-thin low mass skins, bonded to a honeycomb Nomex® core material. Very light and very strong, responds with great speed without bending. RDT II uses C-CAM for the front skin, while the rear skin is made from a woven carbon fibre material. This structure reduces distortion by over 8 dB above 300 Hz.

## TWEETERS

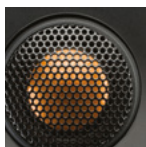

**C-CAM Gold Dome Tweeter:** The Gold Dome tweeter is formed from a Ceramic-Coated Aluminium Magnesium alloy, Gold anodised to a specific thickness for ideal stiffness and damping characteristics. Thinner, lighter, more rigid and more efficient than domes made from other materials which are prone to distortion in the audio band.



**Ribbon Transducer:** An ultra-thin sandwich of C-CAM alloy suspended in a powerful transverse magnetic field of high energy NeFeB rare earth magnets. The ribbon serves as both voice coil and radiating diaphragm, with every part of the ribbon driven directly and simultaneously without energy storage. The diaphragm is specified to reach ultra-high frequencies up to an elusive 100 kHz.



**MPD High Frequency Transducer:** Micro Pleated Diaphragm high frequency transducer uses a proprietary low-mass pleated diaphragm with a surface area eight times larger than that of a traditional dome tweeter. MPD transducers work like a super-fast accordion by rapidly squeezing the pleats to produce a smooth, wide, naturally fast response up to 100 kHz.

## SPECIAL FEATURES

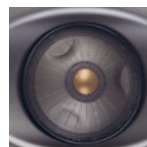

**IDC Driver Module:** Inverted Dual Concentric pivoting mid-range/tweeter module with up to 18 degrees of adjustment in all directions. Sound can be directed toward the desired listening area.

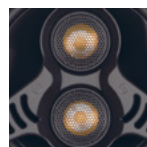

**T2 Dual Tweeter Configuration (Stereo):** Dual, independent, pivoting 1" C-CAM tweeters and dual wound voice coil bass drivers for high performance stereo sound.

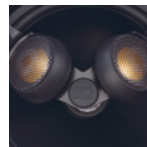

**FX Dual Tweeter Configuration (Surround):** FX speakers are ideal for surround or rear channel use in home cinema applications for a fully immersive experience.



**Adjustable Response Controls:** Optimum imaging and set-up are established via pivoting tweeters, pivoting IDC driver modules, high-frequency, mid-range-frequency, and/or boundary compensation controls.



**Patented Tri-Grip Mounting Clamps:** The Tri-Grip mounting clamps have three clamping points per dogleg. Providing a better seal between the speaker and the ceiling.

# Custom Install Speakers



# Core

Our most versatile Custom Install In-Ceiling speaker range, with a broad selection of models tailored for specific uses.

## In-Ceiling



**C165**

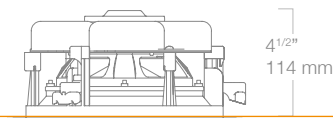

**C165-T2**

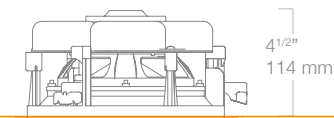

Sensitivity (1W@1m)	88.5 dB	88.5 dB
Cut Out Diameter	8 1/4" / 211 mm	8 1/4" / 211 mm
Mounting Depth	4 1/2" / 114 mm	4 1/2" / 114 mm
Power Handling (RMS)	65 W	65 W
Impedance	6 ohms	6 + 6 ohms
Driver Size & Technology	6 1/2" MMP II driver 1" C-CAM pivoting Gold Dome tweeter HF level switch	6 1/2" MMP II driver 2 x 1" C-CAM pivoting Gold Dome tweeters
Pre-Construction Bracket	CB6 (Purple)	CB6 (Purple)
Back Box	CCBOX-R / CMBOX-R	CCBOX-R / CMBOX-R

**C265**

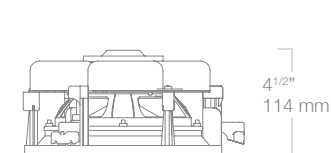

**C265-IDC**

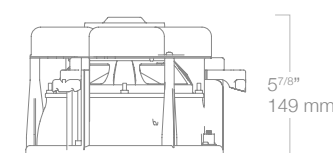

**C265-FX**

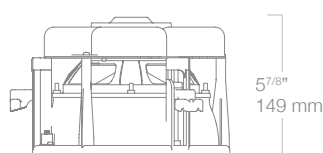

Sensitivity (1W@1m)	88.5 dB	88.5 dB	88.5 dB
Cut Out Diameter	8 1/4" / 211 mm	8 1/4" / 211 mm	8 1/4" / 211 mm
Mounting Depth	4 1/2" / 114 mm	5 7/8" / 149 mm	5 7/8" / 149 mm
Power Handling (RMS)	75 W	85 W	85 W
Impedance	6 ohms	6 ohms	6 ohms
Driver Size & Technology	6 1/2" C-CAM driver 1" C-CAM pivoting Gold Dome tweeter HF level switch Boundary compensation switch	6 1/2" C-CAM driver Pivoting IDC module (4" C-CAM RST inverted mid-range driver, 1" C-CAM Gold Dome tweeter) HF level switch Boundary compensation switch	6 1/2" C-CAM driver 2 x 1" C-CAM Gold Dome tweeters HF level switch Bipole / Dipole switch
Pre-Construction Bracket	CB6 (Purple)	CB6 (Purple)	CB6 (Purple)
Back Box	CCBOX-R / CMBOX-R	CCBOX-L / CMBOX-R	CCBOX-L / CMBOX-R



# Core

C180

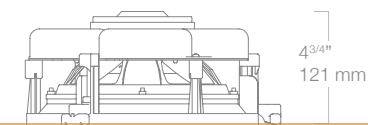

C180-T2

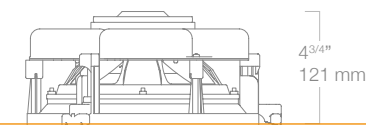

C280

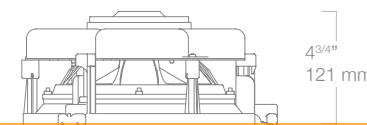

Sensitivity (1W@1m)	90 dB	90 dB	90 dB
Cut Out Diameter	9 <sup>3/4</sup> " / 247 mm	9 <sup>3/4</sup> " / 247 mm	9 <sup>3/4</sup> " / 247 mm
Mounting Depth	4 <sup>3/4</sup> " / 121 mm	4 <sup>3/4</sup> " / 121 mm	4 <sup>3/4</sup> " / 121 mm
Power Handling (RMS)	120 W	120 W	120 W
Impedance	6 ohms	6 + 6 ohms	6 ohms
Driver Size & Technology	8" MMP II driver 1" C-CAM pivoting Gold Dome tweeter HF level switch	8" MMP II driver 2 x 1" C-CAM pivoting Gold Dome tweeters HF level switch	8" C-CAM driver 1" C-CAM pivoting Gold Dome tweeter HF level switch Boundary compensation switch
Pre-Construction Bracket	CB8 (Green)	CB8 (Green)	CB8 (Green)
Back Box	CCBOX-R / CMBOX-R	CCBOX-R / CMBOX-R	CCBOX-R / CMBOX-R

C280-IDC

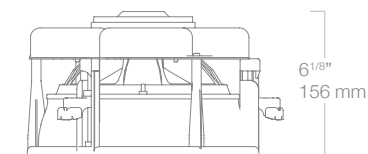

C380-IDC

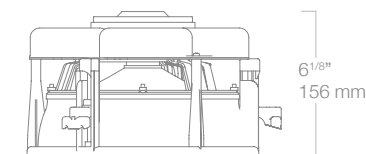

C380-FX

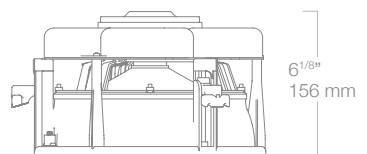

Sensitivity (1W@1m)	90 dB	90 dB	90 dB
Cut Out Diameter	9 <sup>3/4</sup> " / 247 mm	9 <sup>3/4</sup> " / 247 mm	9 <sup>3/4</sup> " / 247 mm
Mounting Depth	6 <sup>1/8</sup> " / 156 mm	6 <sup>1/8</sup> " / 156 mm	6 <sup>1/8</sup> " / 156 mm
Power Handling (RMS)	120 W	150 W	120 W
Impedance	6 ohms	6 ohms	6 ohms
Driver Size & Technology	8" C-CAM driver Pivoting IDC module (4" C-CAM RST inverted mid-range driver, 1" C-CAM Gold Dome tweeter) HF level switch Boundary compensation switch	8" C-CAM RST driver Pivoting IDC module (4" C-CAM RST inverted mid-range driver, 1" C-CAM Gold Dome tweeter) HF level switch Boundary compensation switch	8" C-CAM RST driver 2 x 1" C-CAM Gold Dome tweeters HF level switch Bipole / Dipole switch with additional 12 V trigger switching
Pre-Construction Bracket	CB8 (Green)	CB8 (Green)	CB8 (Green)
Back Box	CMBOX-R	CMBOX-R	CMBOX-R

# Core

Our most versatile Custom Install In-Wall speaker range, with a broad selection of models tailored for specific uses.

## In-Wall Centres

W150-LCR

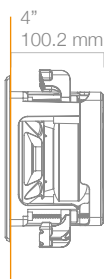

W250-LCR

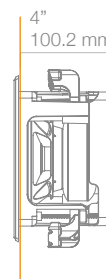

Sensitivity (1W@1m)	88 dB	88 dB
Cut Out Dimensions (H x W)	5 <sup>3/4</sup> " x 13 <sup>7/8</sup> " / 145 x 353 mm	5 <sup>3/4</sup> " x 13 <sup>7/8</sup> " / 145 x 353 mm
Mounting Depth	4" / 100.2 mm	4" / 100.2 mm
Power Handling (RMS)	100 W	100 W
Impedance	8 ohms	8 ohms
Driver Size & Technology	2 x 5" MMP II drivers 1" C-CAM pivoting Gold Dome tweeter Fits within standard 16" / 400 mm centre studs	2 x 5" C-CAM drivers 1" C-CAM pivoting Gold Dome tweeter HF level switch Fits within standard 16" / 400 mm centre studs
Pre-Construction Bracket	WB5LCR (Yellow)	WB5LCR (Yellow)

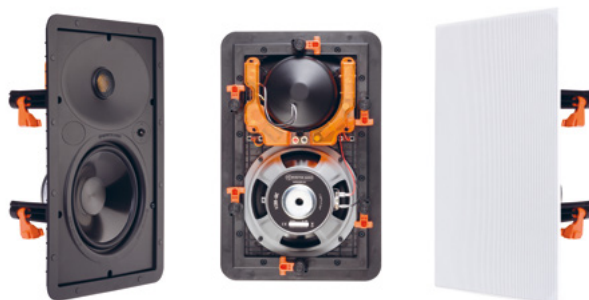

## In-Wall

W165

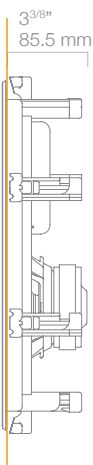

W265

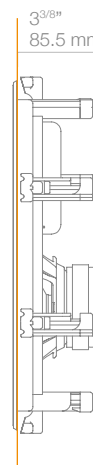

Sensitivity (1W@1m)	88.5 dB	88.5 dB
Cut Out Dimensions (H x W)	13 <sup>1/16</sup> " x 8 <sup>3/8</sup> " / 332 x 213 mm	13 <sup>1/16</sup> " x 8 <sup>3/8</sup> " / 332 x 213 mm
Mounting Depth	3 <sup>3/8</sup> " / 85.5 mm	3 <sup>3/8</sup> " / 85.5 mm
Power Handling (RMS)	65 W	65 W
Impedance	6 ohms	6 ohms
Driver Size & Technology	6 <sup>1/2</sup> " MMP II driver 1" C-CAM pivoting Gold Dome tweeter HF level switch	6 <sup>1/2</sup> " C-CAM driver 1" C-CAM pivoting Gold Dome tweeter HF level switch Boundary compensation switch
Pre-Construction Bracket	WB6 (Purple)	WB6 (Purple)

# Core

## W180

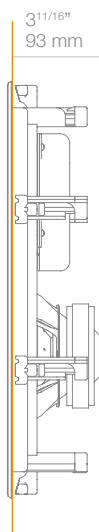

## W280

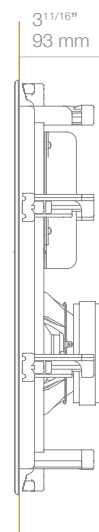

Sensitivity (1W@1m)	90 dB	90 dB
Cut Out Dimensions (H x W)	15 1/4" x 9 3/16" / 387 x 234 mm	15 1/4" x 9 3/16" / 387 x 234 mm
Mounting Depth	3 11/16" / 93 mm	3 11/16" / 93 mm
Power Handling (RMS)	120 W	120 W
Impedance	6 ohms	6 ohms
Driver Size & Technology	8" MMP II driver 1" C-CAM pivoting Gold Dome tweeter HF level switch	8" C-CAM driver 1" C-CAM pivoting Gold Dome tweeter HF level switch Boundary compensation switch
Pre-Construction Bracket	WB8 (Green)	WB8 (Green)
Back Box	WCBOX-L	WCBOX-L

## W280-IDC

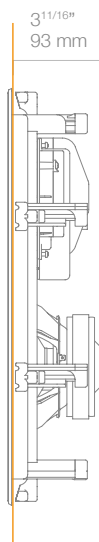

## W380-IDC

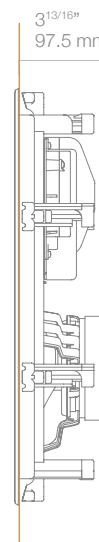

Sensitivity (1W@1m)	90 dB	90 dB
Cut Out Dimensions (H x W)	15 1/4" x 9 3/16" / 387 x 234 mm	15 1/4" x 9 3/16" / 387 x 234 mm
Mounting Depth	3 11/16" / 93 mm	3 13/16" / 97.5 mm
Power Handling (RMS)	150 W	150 W
Impedance	6 ohms	6 ohms
Driver Size & Technology	8" C-CAM driver Pivoting IDC module (4" C-CAM RST inverted mid-range driver, 1" C-CAM Gold Dome tweeter) HF level switch Boundary compensation switch	8" C-CAM RST driver Pivoting IDC module (4" C-CAM RST inverted mid-range driver, 1" C-CAM Gold Dome tweeter) HF & MF level switches Boundary compensation switch
Pre-Construction Bracket	WB8 (Green)	WB8 (Green)
Back Box	WCBOX-L	WCBOX-L

# Slim

Having a physical depth of less than 4" / 100 mm, the Slim models are perfect for easy installation in many more locations, being ideal for standard stud walls and where depth is restricted. Integrating the bass driver basket with the frame, our engineers have reduced overall speaker size by 25% over conventional speakers without any performance penalty.

## In-Ceiling / In-Wall

CS140 Round / Square

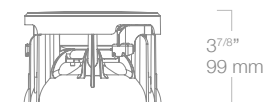

CS160 Round / Square

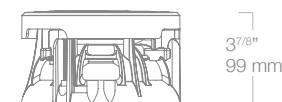

CS180 Round / Square

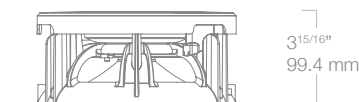

Sensitivity (1W@1m)	85 dB	88 dB	90 dB
Cut Out Diameter	5 <sup>7/8</sup> " / 149 mm	6 <sup>11/16</sup> " / 170 mm	8 <sup>3/8</sup> " / 213 mm
Mounting Depth	3 <sup>7/8</sup> " / 99 mm	3 <sup>7/8</sup> " / 99 mm	3 <sup>15/16</sup> " / 99.4 mm
Power Handling (RMS)	50 W	70 W	120 W
Impedance	6 ohms	6 ohms	6 ohms
Driver Size & Technology	4" MMP II driver 1" C-CAM pivoting Gold Dome tweeter	6" MMP II driver 1" C-CAM pivoting Gold Dome tweeter	8" MMP II driver 1" C-CAM pivoting Gold Dome tweeter
Pre-Construction Bracket	CB4 (Pink)	CB5 (Blue)	CB6 (Purple)
Back Box	CCBOX-R	CCBOX-R / CMBOX-R	CCBOX-R / CMBOX-R



NOTE : All Slim models can be ordered as a round or square grille option.

# Super Slim

Our innovative Super Slim speakers back box design delivers full frequency performance with wide installation versatility. Ideal for standard stud walls and where depth is very restricted. The Super Slim In-Wall products are designed for both vertical or horizontal installation.

## In-Ceiling

CSS230

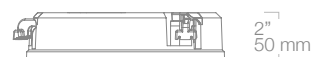

Closed back

Opened back



Sensitivity (1W@1m)	86 dB
Cut Out Diameter	8 <sup>1</sup> / <sub>4</sub> " / 211 mm
Mounting Depth	2" / 50 mm
Power Handling (RMS)	40 W – Full range 60 W – With crossover set to 100 Hz @ 12 dB/Octave
Impedance	8 ohms
Driver Size & Technology	3 x 3" C-CAM drivers, enabling slim profile with the performance of a single 6" driver 3/4" C-CAM pivoting Gold Dome tweeter Sealed rear enclosure for acoustic isolation back box Rubber plug can be removed for open back design and increased low frequency performance
Pre-Construction Bracket	CB6 (Purple)

## In-Wall

AVAILABLE  
December 2017

WSS130



2"  
50 mm

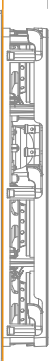

WSS230



2"  
50 mm



WSS430



2"  
50 mm



Sensitivity (1W@1m)	87 dB	87 dB	87 dB
Cut Out Dimensions (H x W)	13 <sup>1</sup> / <sub>2</sub> x 4" / 346 x 101 mm	13 <sup>1</sup> / <sub>2</sub> x 4" / 346 x 101 mm	13 <sup>1</sup> / <sub>2</sub> x 4" / 346 x 101 mm
Mounting Depth	2" / 50 mm	2" / 50 mm	2" / 50 mm
Power Handling (RMS)	60 W – Full range 100 W – With crossover set to 100Hz@12dB/Octave	60 W – Full range 100 W – With crossover set to 100Hz@12dB/Octave	75 W – Full range 120 W – With crossover set to 100Hz@12dB/Octave
Impedance	8 ohms	8 ohms	8 ohms
Driver Size & Technology	3 x 3" MMP II drivers, enabling slim profile with the performance of a single 6" driver 1" C-CAM pivoting Gold Dome tweeter	3 x 3" C-CAM drivers, enabling slim profile with the performance of a single 6" driver 1" C-CAM pivoting Gold Dome tweeter	3 x 3" C-CAM drivers, enabling slim profile with the performance of a single 6" driver MPD high frequency transducer – rotatable for vertical or horizontal installation
Pre-Construction Bracket	WB3 (Dark blue)	WB3 (Dark blue)	WB3 (Dark blue)

### WSS430

The WSS430 uses concepts and materials taken directly from our flagship Platinum II speakers. Almost every component is unique to this model, created to deliver the most critical of audiophile and cinema experiences with superlative ease. The WSS430 MPD high frequency transducer is designed to rotate 90° to suit the chosen speaker installation.



# Controlled Performance

The Controlled Performance (CP) range is fitted with fully-sealed back boxes that provide an ideal air load for the drivers, optimising mid-range and bass performance while maintaining sonic consistency regardless of interior wall construction. These rigid, mineral filled enclosures reduce the sound from the back of the cabinet by around 30 dB. This range guarantees excellent audio quality and versatility, for superior level of sound isolation between rooms and floors.



## In-Ceiling

CP-CT150

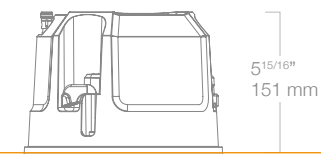

CP-CT260

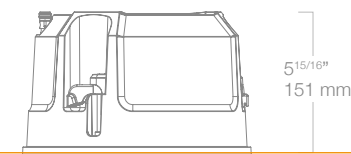

Sensitivity (1W@1m)	85 dB	88 dB
Cut Out Diameter	8 <sup>3/8</sup> " / 212 mm	9 <sup>5/8</sup> " / 244 mm
Mounting Depth	5 <sup>15/16</sup> " / 151 mm	5 <sup>15/16</sup> " / 151 mm
Power Handling (RMS)	50 W	65 W
Impedance	6 ohms	6 ohms
Driver Size & Technology	5" MMP II driver 1" C-CAM pivoting Gold Dome tweeter HF level switch	6" C-CAM driver 1" C-CAM pivoting Gold Dome tweeter HF level switch Boundary compensation switch
Pre-Construction Bracket	CB6 (Purple)	CB8 (Green)
Back Box	CCBOX-L	CCBOX-L

CP-CT380

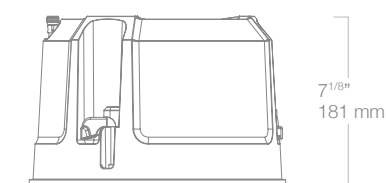

CP-CT380IDC

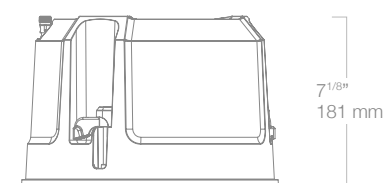

Sensitivity (1W@1m)	89 dB	89 dB
Cut Out Diameter	10 <sup>13/16</sup> " / 274 mm	10 <sup>13/16</sup> " / 274 mm
Mounting Depth	7 <sup>1/8</sup> " / 181 mm	7 <sup>1/8</sup> " / 181 mm
Power Handling (RMS)	120 W	120 W
Impedance	6 ohms	6 ohms
Driver Size & Technology	8" C-CAM RST driver 1" C-CAM pivoting Gold Dome tweeter HF level switch Boundary compensation switch	8" C-CAM RST driver Pivoting IDC module (4" C-CAM RST inverted mid-range driver, 1" C-CAM Gold Dome tweeter) HF & MF level switches Boundary compensation switch
Pre-Construction Bracket	CB10 (Light brown)	CB10 (Light brown)

# Controlled Performance



## In-Wall

CP-WT150

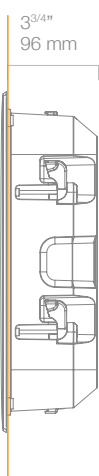

CP-WT260

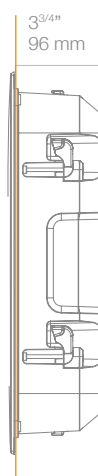

Sensitivity (1W@1m)	85 dB	88 dB
Cut Out Dimensions (H x W)	12 <sup>13/16"</sup> x 8 <sup>1/8"</sup> / 326 x 207 mm	15" x 9" / 381 x 228 mm
Mounting Depth	3 <sup>3/4"</sup> / 96 mm	3 <sup>3/4"</sup> / 96 mm
Power Handling (RMS)	50 W	65 W
Impedance	6 ohms	6 ohms
Driver Size & Technology	5" MMP II driver 1" C-CAM pivoting Gold Dome tweeter HF level switch	6" C-CAM driver 1" C-CAM pivoting Gold Dome tweeter HF level switch Boundary compensation switch
Pre-Construction Bracket	WB6 (Purple)	WB8 (Green)
Back Box		WCBOX-L

CP-WT380

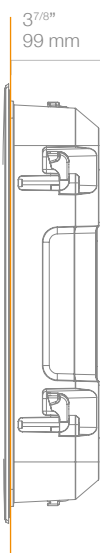

CP-WT380IDC

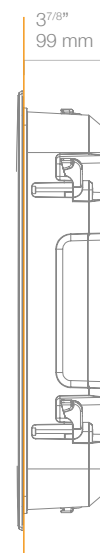

Sensitivity (1W@1m)	89 dB	89 dB
Cut Out Dimensions (H x W)	17 <sup>1/4"</sup> x 10 <sup>9/16"</sup> / 438 x 269 mm	17 <sup>1/4"</sup> x 10 <sup>9/16"</sup> / 438 x 269 mm
Mounting Depth	3 <sup>7/8"</sup> / 99 mm	3 <sup>7/8"</sup> / 99 mm
Power Handling (RMS)	120 W	120 W
Impedance	6 ohms	6 ohms
Driver Size & Technology	8" C-CAM RST driver 1" C-CAM pivoting Gold Dome tweeter HF level switch Boundary compensation switch	8" C-CAM RST driver Pivoting IDC module (4" C-CAM RST inverted mid-range driver, 1" C-CAM gold dome tweeter) HF & MF level switches Boundary compensation switch
Pre-Construction Bracket	WB10 (Light brown)	WB10 (Light brown)

# Controlled Performance

## In-Wall Centres

CP-WT140LCR

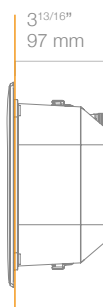

Sensitivity (1W@1m)	88 dB
Cut Out Dimensions (H x W)	7 <sup>3/16</sup> " x 11 <sup>3/4</sup> " / 183 x 299 mm
Mounting Depth	3 <sup>13/16</sup> " / 97 mm
Power Handling (RMS)	100 W
Impedance	6 ohms
Driver Size & Technology	2 x 4" MMP II drivers 1" C-CAM pivoting Gold Dome tweeter HF level switch
Pre-Construction Bracket	WB4LCR (Dark brown)

CP-WT240LCR

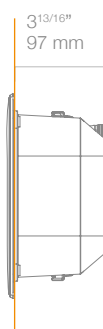

Sensitivity (1W@1m)	88 dB
Cut Out Dimensions (H x W)	7 <sup>3/16</sup> " x 11 <sup>3/4</sup> " / 183 x 299 mm
Mounting Depth	3 <sup>13/16</sup> " / 97 mm
Power Handling (RMS)	100 W
Impedance	6 ohms
Driver Size & Technology	2 x 4" C-CAM drivers 1" C-CAM pivoting Gold Dome tweeter HF level switch Boundary compensation switch
Pre-Construction Bracket	WB4LCR (Dark brown)

## Performance Full Size

CP-IW260X

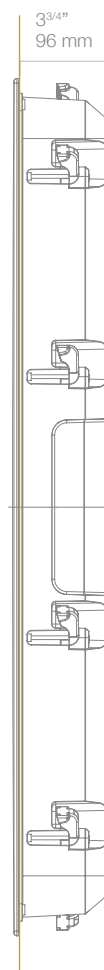

Sensitivity (1W@1m)	89 dB
Cut Out Dimensions (H x W)	34 <sup>21/32</sup> " x 9" / 880 x 230 mm
Mounting Depth	3 <sup>3/4</sup> " / 96 mm
Power Handling (RMS)	150 W
Impedance	6 ohms
Driver Size & Technology	2 x 6 <sup>1/2</sup> " C-CAM bass drivers 2 x 4" C-CAM mid-range drivers 1" C-CAM Gold Dome tweeter HF & MF level switches Boundary compensation switch Vertical or horizontal orientation
Pre-Construction Bracket	WB12 (Green)





# Controlled Performance

## Performance Full Size

CP-IW460X

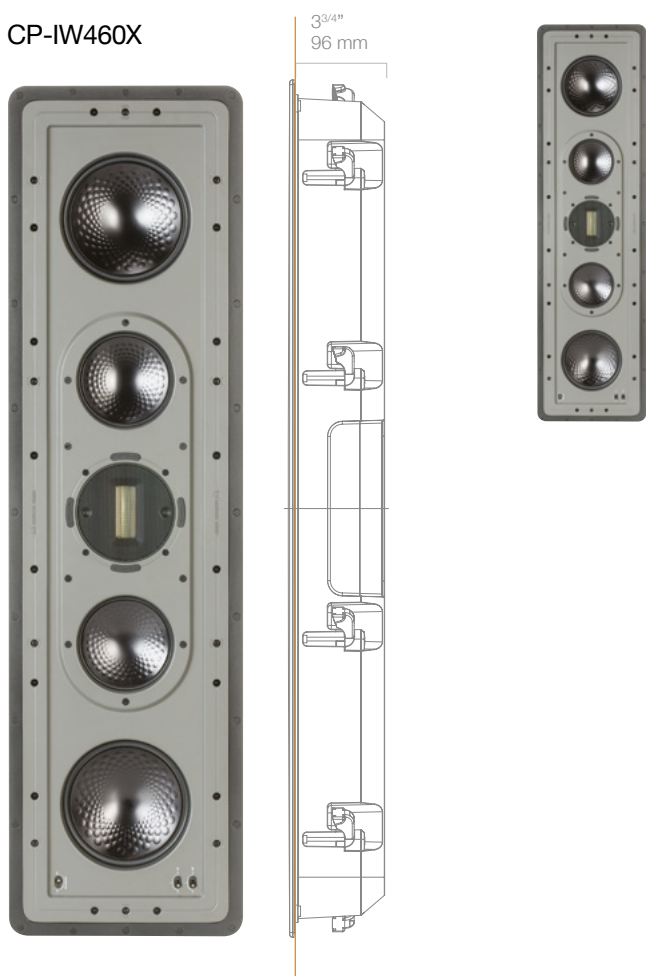

### Performance Full Size

The CP-IW260X and CP-IW460X In-Wall designs have overcome the challenges of scale to deliver the natural, full range audio energy you'd expect from a free-standing high-end box. In a leap of engineering ingenuity, we've distilled the know-how driving our hi-fi speakers into a super-compact In-Wall format. Dedicated music lovers and home theatre fans can enjoy the rich, detailed, high-impact dynamics they crave, from a speaker that physically disappears in the room. Both Full Size models can be installed in vertical or horizontal orientations, with the high frequency ribbon transducer of the CP-IW460X designed to rotate 90° to suit the chosen speaker placement.



Sensitivity (1W@1m)	89 dB
Cut Out Dimensions (H x W)	34 <sup>21/32</sup> " x 9" / 880 x 230 mm
Mounting Depth	3 <sup>3/4</sup> " / 96 mm
Power Handling (RMS)	150 W
Impedance	6 ohms
Driver Size & Technology	2 x 6 <sup>1/2</sup> " C-CAM RST bass drivers 2 x 4" C-CAM RST mid-range drivers High frequency ribbon transducer Die-cast alloy bass driver chassis provides rigidity; results in punch bass and clean mid-range performance due to reduced transfer of vibrations HF & MF level switches Boundary compensation switch Innovative HF tweeter rotating system to facilitate vertical or horizontal orientation
Pre-Construction Bracket	WB12 (Green)



# Controlled Performance

At only 3<sup>1</sup>/<sub>8</sub>" / 80 mm diameter, Monitor Audio's CPC120 is a loudspeaker that offers extraordinary sound quality for a truly innovative application. Its precision engineered micro design allows it to offer a surprisingly coherent and detailed performance from a standard GU10 sized halogen down-lighter hole. The CPC120 can be specified with three different grille bezel options.

## In-Ceiling GU10 Size



Sensitivity (1W@1m)	85 dB
Cut Out Diameter	2 <sup>1</sup> / <sub>2</sub> " / 65 mm
Mounting Depth	3 <sup>5</sup> / <sub>8</sub> " / 91.5 mm
Power Handling (RMS)	20 W / 50 W using a crossover @ 200 Hz
Impedance	8 ohms
Driver Size & Technology	2" Full range micro-driver Sealed back box Quick and easy discreet flush fitment to ceilings or walls Conventional fitment clips offer quick and simple installation Available in three finishes (brushed steel, white and brass)

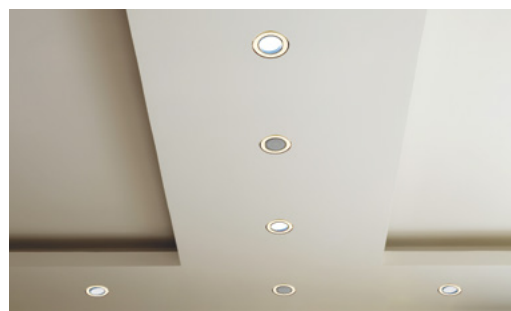

# Flush Fit

For ultimate visual appearance use the aesthetically attractive Flush Fit CF230 speaker. It's flexible and can be used on its own or in multiples. Set up as a 2.1 system with complementary ICS-8 subwoofer it will out perform traditional Custom Install speakers. It comes in a choice of install options: 1. Flush Fit or 2. Retrofit with round and square grilles.

## In-Ceiling

### CF230



Sensitivity (1W@1m)	82.5 dB
Cut Out Diameter	Flush Fit 4 <sup>3/4"</sup> / 120 mm
	Retrofit 3 <sup>9/16"</sup> / 90 mm
Mounting Depth	3 <sup>5/16"</sup> / 83.5 mm
Power Handling (RMS)	30 W – Full range – IEC268-5 rating 100 W – Music program (Using High Pass crossover filter @120 Hz)
Impedance	8 ohms
Driver Size & Technology	3 <sup>1/2"</sup> Bass/mid-range driver, featuring C-CAM cone 3/4" C-CAM Gold Dome tweeter
Brackets	1. Flush Fit – CFB3-R (round grille) or CFB3-SQ (square grille) Pre-construction bracket included in above kits 2. Retrofit – CFB3-KIT (round and square grilles)



Installation Guide video available, scan the QR code or visit:  
[vimeo.com/monitormedia/cf230](https://vimeo.com/monitormedia/cf230)



CFB3-R Flush Fit round grille



CFB3-SQ Flush Fit square grille

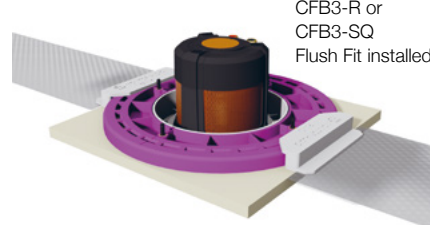

CFB3-R or CFB3-SQ Flush Fit installed

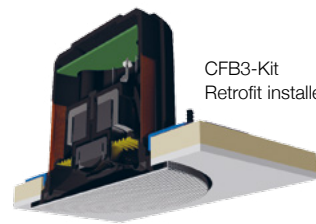

CFB3-Kit Retrofit installed

### CFB3-R (Round) and CFB3-SQ (Square) – Pre-Construction Flush Fit Brackets

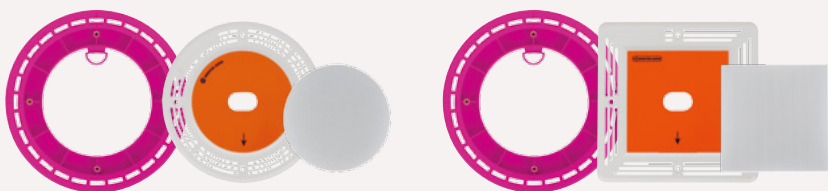

In a pre-construction set-up, the CF230 package enables a seamless, flush fit appearance. You get clean lines, with no shadow-creating edges, and paint the grille to match the ceiling and the speaker disappears even further into the background. Order either **round** or **square** option.

### CFB3-KIT – Retrofit Bracket



The CFB3-KIT retrofit installation kit cleverly provides a firm fixing behind plasterboard/Sheetrock and requires just three screws to complete the fit.

**NOTE:** The retrofit option is not flush fitting and the grille will sit slightly proud of the ceiling surface.

The CF230 is installed using one of the brackets featured above. The Pre-Construction Flush Fit (new build) and Retrofit (existing) options are key to upholding its flexibility claims. Its ability to fit into any set-up means that the speaker is easier to install and more economical than other models.



Compatible product for this range:  
In-Ceiling Subwoofer ICS-8.  
[See page 30 for details.](#)

# Invisible

An invisible audio soundstage is a powerful attraction for homeowners, architects and designers. When so much is invested in creating a beautiful interior space, then it can be difficult to compromise that aesthetic with unsightly speaker grilles. The IV140 invisible speaker delivers 'best in class' audio performance in concealed In-Wall and In-Ceiling applications. It meets the demands of designers, installers and end users by providing ultimate discretion with easy to fit installation and high performance. The IV140 fits into all conventional 4" stud bays, leaving enough room for cabling. Once installed and skimmed with plaster, the speaker is completely out of sight, with paint, light wallpaper or fabric hiding it from view. Large low frequency transducer and two high frequency transducers provide punchy, high power bass and sound vibration. Integrated back box design isolates sound and ensures consistent controlled performance with an optional removable acoustic cover for more bass if required.

## In-Wall

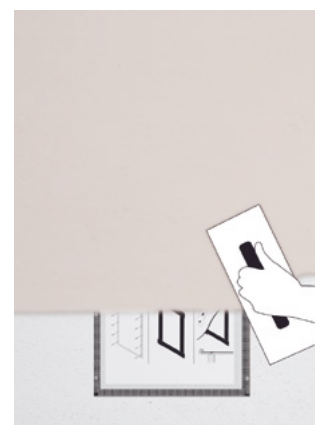
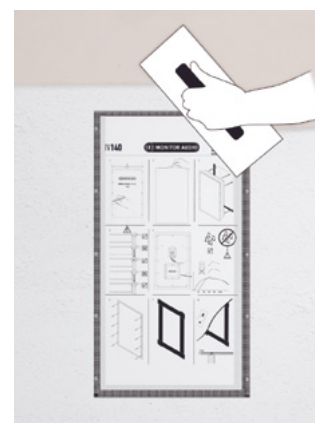

### Installation

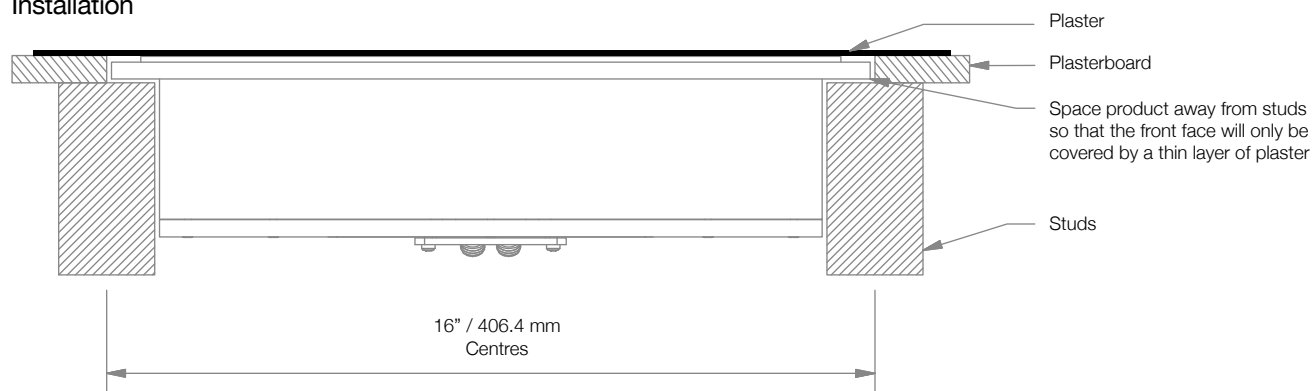

# Invisible

IV140

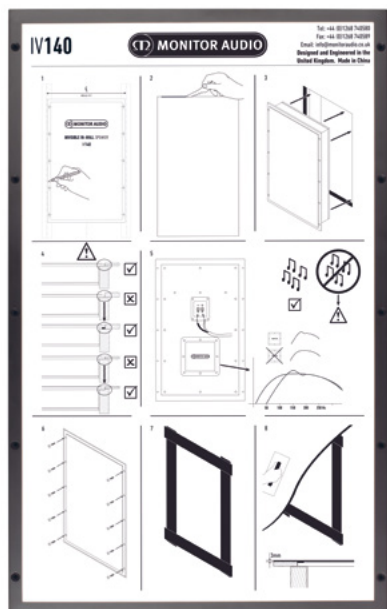

Closed back

IV140 shown above without membrane for highlighting driver arrangement purposes only and acoustic cover in place (CP)



Opened back

With membrane in place and rear acoustic cover removed

Sensitivity (1W@1m)	82 dB (when installed as directed)
Cut Out Dimensions (H x W)	23 <sup>1/4</sup> " x 13 <sup>13/16</sup> " / 591 x 350.5 mm
Mounting Depth	3 <sup>13/16</sup> " / 83.5 mm
Power Handling (RMS)	50 W – Full range – IEC268-5 rating 100 W – Music program (Using Minimum 80 Hz High Pass filter)
Impedance	8 ohms
Technology	Low frequency transducer – Featuring high power ceramic magnetics and 40 mm voice coil Dual high frequency transducers – Incorporating high power Neo magnets and 30 mm voice coils 2-way system with integrated crossover Pre-construction speaker designed to be plastered in to create 'invisible' appearance Rigid MDF back box construction Integrated 'hybrid' controlled performance back box system – Fully sealed or opened back High Quality crossover – Including metallised film capacitors and low loss steel core inductors Protected against overload by PTC's (automatically re-setting breakers) Ideal for home cinema, distributed audio, hospitality, retail and commercial background music applications where aesthetics and discretion are key factors
Pre-Construction Bracket	WBIV140

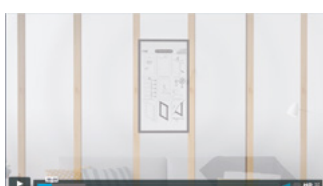
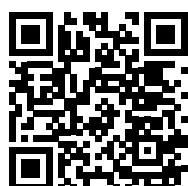

Installation Guide video available, scan the QR code or visit:  
[vimeo.com/monitordaudio/iv140](https://vimeo.com/monitordaudio/iv140)

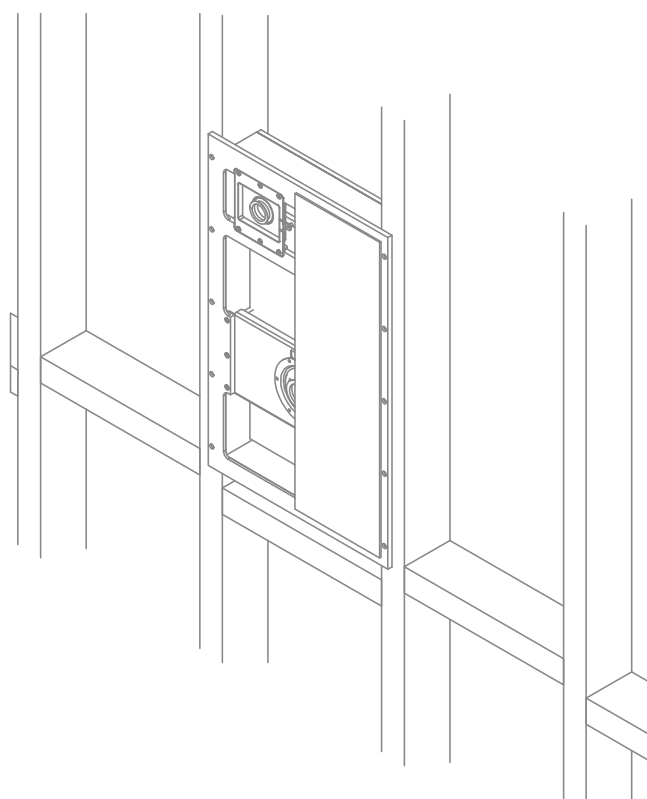

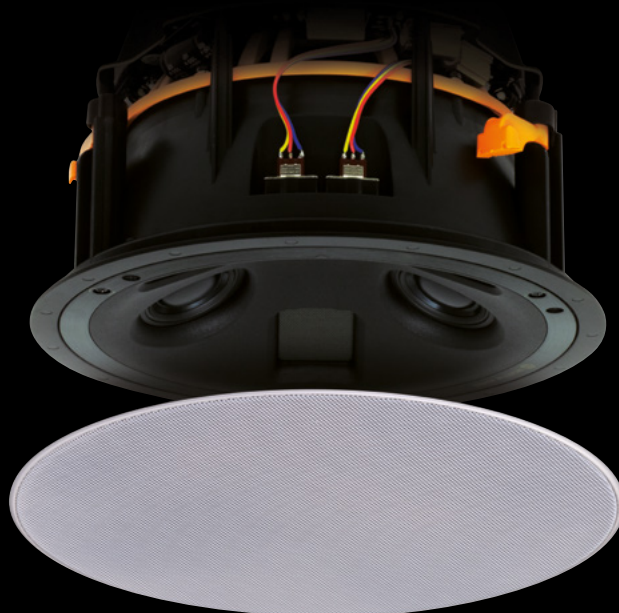

# Perfection Elevated

## PLATINUM II In-Ceiling Speaker

### Platinum II Technology



**RDT II (Rigid Diaphragm Technology 2nd Generation) Driver:** A composite 'sandwich' structure made from ultra-thin low mass skins, bonded to a honeycomb Nomex® core material. It is very light and very strong, meaning that it can respond with great speed without bending – just like a perfect piston. RDT II uses C-CAM for the front skin, while the rear skin is made from a woven carbon fibre material. We discovered that the new structure reduces distortion by over 8 dB above 300 Hz, which makes RDT II the lowest distortion cone technology in Monitor Audio's history.



**MPD (Micro Pleated Diaphragm) High Frequency Transducer:** Developed over many months of intensive testing and listening, the MPD High Frequency Transducer is a landmark achievement by the engineering team for Platinum II. It represents an imaginative re-working of an existing technology, transforming a successful idea into an audiophile super-driver, having greater accuracy and efficiency than ever before. Using, proprietary low-mass pleated diaphragm with a surface area eight times larger than that of a traditional dome tweeter. The MPD transducer works like a super-fast accordion by rapidly squeezing the pleats to produce a smooth, wide, naturally fast response up to 100 kHz. As a result it sounds more lifelike, releasing the high harmonic spectrum of every note without the distortion that blurs definition.

# PLATINUM II

For over 7 years, Monitor Audio engineers have been working towards the unveiling of the Platinum II flagship range. With our most advanced driver, crossover and acoustics systems set within luxurious cabinets, we've tuned the virtues that have won Monitor Audio worldwide acclaim to a new intensity, allowing rarefied audio transparency to be revealed and enjoyed. Platinum II is our magnum opus, as inspirational and satisfying to us as we hope it will be to you.

## In-Ceiling

### PLIC II

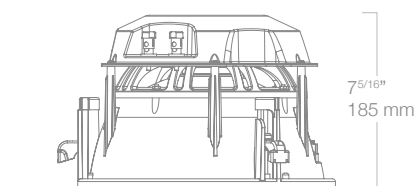

The PLIC II In-Ceiling speaker offers unsurpassed levels of performance, delivering sublime audio accuracy. Providing a winning combination of high quality sound, ease of installation and discreet design, this speaker will be a firm favourite with home technology installers, architects, interior designers and end users.

Sensitivity (1W@1m)	90 dB
Cut Out Diameter	10 <sup>3/4</sup> " / 273 mm
Mounting Depth	7 <sup>5/16</sup> " / 185 mm
Power Handling (RMS)	150 W
Impedance	4 ohms Nominal (3.1 ohms minimum @ 1.1 kHz)
Driver Size & Technology	8" long-throw RDT II bass driver 2 x 2" C-CAM mid-range drivers – full three-way design MPD high frequency transducer Angled mid-range and high frequency drivers – directed towards listening area to provide uniform mid and high frequency dispersion High-performance 'no compromise' flagship speaker product Rigid aluminium baffle construction Highest quality 'push' style termination Mid-range and HF level adjustment switches (+1/0/-1 dB) Paintable, trim less/low profile circular magnetic grille design – square option available Highest quality crossover design – including metallised polypropylene capacitors and low loss inductors Patented Tri-Grip mounting clamps
Pre-Construction Bracket	CB10 (Light brown)
Back Box	PLIC-BOX II – specially designed pre-construction enclosure provides ideal controlled performance or a bespoke sealed enclosure of 24 Litres

### Platinum II In-Ceiling Back Box



Overall Dimensions  
(Including Brackets):  
7<sup>1/2</sup> x 24<sup>3/4</sup> x 13<sup>3/4</sup>"  
191.2 x 628.6 x 350 mm  
Internal volume 24 L

### PLIC-BOX II

To ensure controlled audio performance for the PLIC II, Monitor Audio has designed an optional pre-construction MDF back box with pre-determined air volume of 24 L. The rigid box is available with pre-loaded internal damping material to provide the best possible sound absorption and reduce standing waves.



# PLATINUM II

## In-Wall

Platinum In-Wall II



The Platinum In-Wall II is a three-way reference architectural speaker system, perfect for custom home theatre projects where lifelike scale and dynamics are demanded. Equipped with an adjustable mid/high frequency driver array, this unit is able to deliver pin-point audio imaging and consistency from both vertical or horizontal orientations. By rotating the array though 90 degrees at the centre of a LCR configuration for instance, a soundstage of three Platinum In-Wall II's will generate the seamless tonal integrity of the finest boxed systems from a stealthy In-Wall location.

Sensitivity (1W@1m)	90 dB
Cut Out Dimensions (H x W)	46 1/4 x 11 13/16" / 1175 x 300 mm
Mounting Depth	3 13/16" / 97.5 mm
Power Handling (RMS)	200 W
Impedance	4 ohms (3.7 ohms min. @ 2.8 kHz)
Driver Size & Technology	2 x 6 1/2" RDT II bass drivers 4" RDT II mid-range driver MPD high frequency transducer Mid-range/tweeter module rotates for vertical or horizontal orientations HF & MF level switches (+1/0/-1 dB) Flagship In-Wall luxury speaker Less than 4" mounting depth



Platinum In-Wall II can be installed in vertical or horizontal orientations



# Pro Speakers



The PRO range is ideal for projects with large quantity of compact speakers for example in spaces like shopping malls, hotel lobbies, restaurants, office complex and general domestic use. It brings to custom installers highly flexible ultimate compact architectural speakers, with driver technology refined to deliver unparalleled sonic performance and increased flexibility in discrete installations.

**PRO-80LV**  
commercial speaker with  
70/100 V line power taps  
Ideal for projects with a large quantity  
of speakers over large distances. It  
also provides flexible design options  
configured in line level.

## In-Ceiling

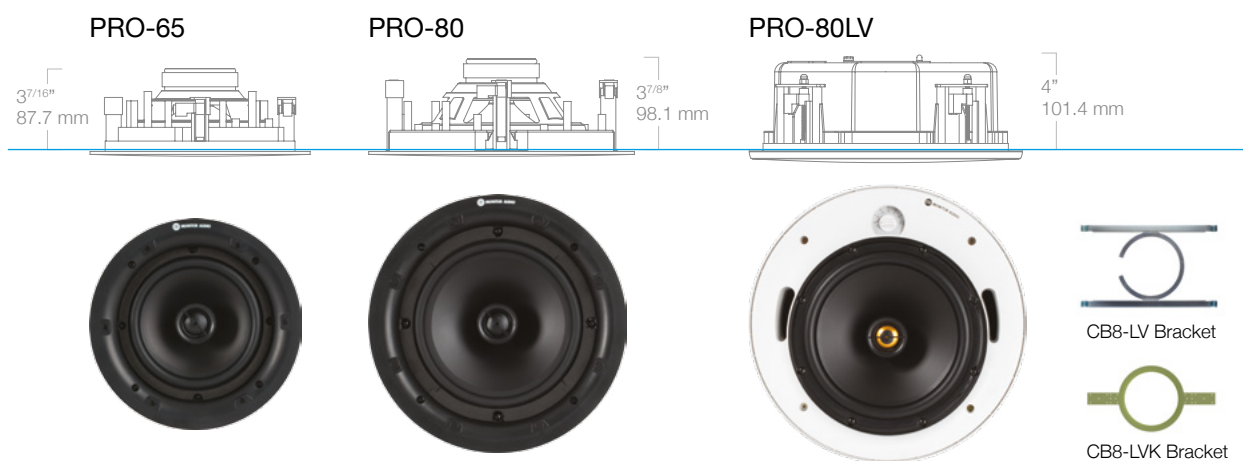

Sensitivity (1W@1m)	86 dB	87 dB	87 dB
Cut Out Diameter	8 <sup>1</sup> / <sub>16</sub> " / 205 mm	9 <sup>3</sup> / <sub>4</sub> " / 248 mm	10 <sup>1</sup> / <sub>2</sub> " / 266 mm
Mounting Depth	3 <sup>7</sup> / <sub>16</sub> " / 87.7 mm	3 <sup>7</sup> / <sub>8</sub> " / 98.1 mm	4" / 101.4 mm
Power Handling (RMS)	30 W	40 W	40 W
Impedance	8 ohms	8 ohms	16 ohms 70 V (4,8,16,32,64 W) / 100 V (8,16,32,64 W) power selection
Driver Size & Technology	6 <sup>1</sup> / <sub>2</sub> " MMP II driver 1" pivoting tweeter Only available in packs of 5	8" MMP II driver 1" pivoting tweeter Only available in packs of 5	8" MMP II driver 1" C-CAM Gold Dome tweeter Ideal for projects with a large quantity of speakers over large distances Transformer with 70/100 V input for installation on one amplifier channel 16 ohms, power level taps at 4,8,16,32 W Fireproof steel rear can – Fire Rating: UL1480 & UL2043 'Easy-fit' connection block – Provides link out for 'daisy chain' connection Anchor point fixings Only available in packs of 4
Pre-Construction Bracket	PRO-IC65 Construction Bracket	CB8 (Green)	CB8-LV CB8-LVK

# Weather Resistant Speakers



# All Weather

The All Weather In-Ceiling series has a weatherproof construction for installation in more extreme environments such as bathrooms, beach houses, saunas or even boats. It offers long-term high performance reliability being built with heightened levels of water, dust, corrosion, UV and temperature protection. These speakers feature super-discreet Stainless Steel grilles and are certified against salt spray, UV stability, water, vibration and anti-corrosion. Operating temperature range: -29° to 174° F / -34° to 79° C.



## In-Ceiling

### AWC265

### AWC265-T2

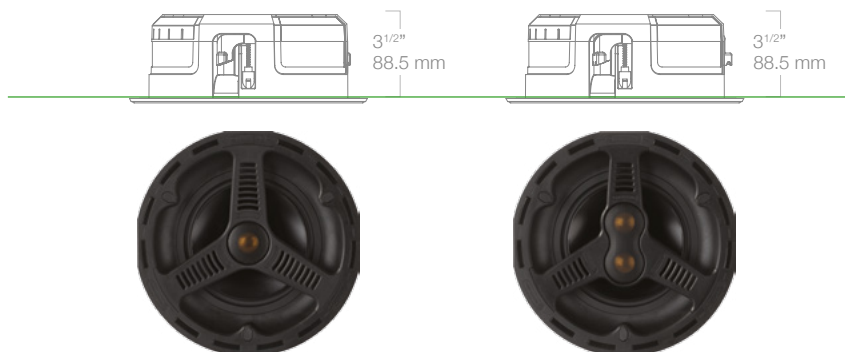

Sensitivity (1W@1m)	88 dB	88 dB (both channels driven)
Cut Out Diameter	8 1/4" / 211 mm	8 1/4" / 211 mm
Mounting Depth	3 1/2" / 88.5 mm	3 1/2" / 88.5 mm
Power Handling (RMS)	60 W	2 x 50 W
Impedance	8 ohms / 4.4 ohms @ 190 Hz	8 + 8 ohms / 4.5 ohms @ 185 Hz
Driver Size & Technology	6 1/2" C-CAM driver 1" C-CAM Gold Dome tweeter HF level switch	6 1/2" C-CAM driver 2 x 1" C-CAM Gold Dome tweeters HF level switch
IP Rating	Front: IP55 Rear: IP4X	Front: IP55 Rear: IP4X
Pre-Construction Bracket	CB6 (Purple)	CB6 (Purple)
Back Box	CCBOX-R / CMBOX-R	CCBOX-R / CMBOX-R



Gold plated push terminals with silicone cover

### AWC280

### AWC280-T2

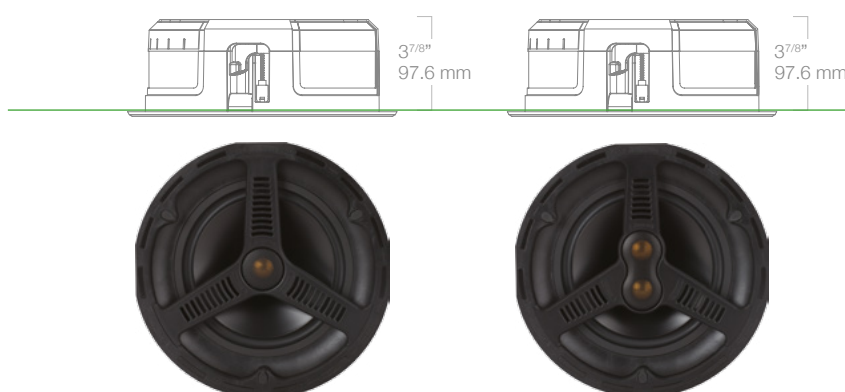

Sensitivity (1W@1m)	89 dB	89 dB (both channels driven)
Cut Out Diameter	9 3/4" / 247 mm	9 3/4" / 247 mm
Mounting Depth	3 7/8" / 97.6 mm	3 7/8" / 97.6 mm
Power Handling (RMS)	100 W	2 x 50 W
Impedance	8 ohms / 4.5 ohms @ 185 Hz	8 + 8 ohms / 4.5 ohms @ 185 Hz
Driver & Technology	8" C-CAM driver 1" C-CAM Gold Dome tweeter HF level switch	8" C-CAM driver 2 x 1" C-CAM Gold Dome tweeters HF level switch
IP Rating	Front: IP55 Rear: IP4X	Front: IP55 Rear: IP4X
Pre-Construction Bracket	CB8 (Green)	CB8 (Green)
Back Box	CCBOX-R / CMBOX-R	CCBOX-R / CMBOX-R



Stainless steel fixing screws with Neoprene covers



Dust protection covers on driver and crossover splash and humidity proof for installation in shower and pool areas

# Climate

With the advent of the versatile Climate range, no environment is beyond the reach of great sound, whatever the weather! This range is certified to be resistant to UV, corrosion and water. Wall mounted in any combination, it provides a wide and even dispersion of full range sound over large areas. Low frequencies are augmented from an Auxiliary Bass Radiator (ABR) in each cabinet. Paintable textured white or black finishes with weatherproof aluminium grilles. Operating temperature range: -13° to 149° F / -25° to 65° C.

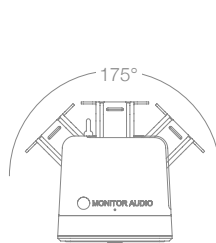

Bracket allows for 175° rotation on horizontal axis



Speaker position can be fine tuned by using optional 15° angle block



Vertical or horizontal orientation. Rotational 'M' logo

## Wall Mounted



Climate 50

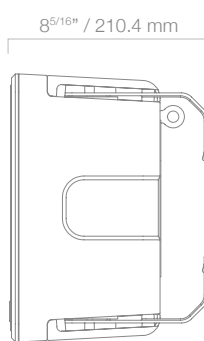

Climate 60

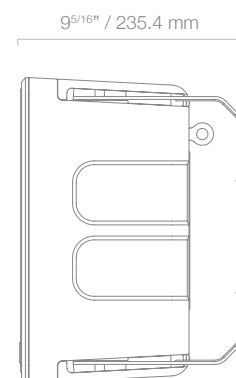

Sensitivity (1W@1m)	87 dB	88 dB
Overall Dimensions With Grille (H x W x D)	11 <sup>1/4</sup> x 6 <sup>13/16</sup> x 6 <sup>5/16</sup> / 285 x 172.5 x 160 mm (Overall Depth With Bracket: 8 <sup>5/16</sup> / 210.4 mm)	12 <sup>13/16</sup> x 7 <sup>5/16</sup> x 7 <sup>2/16</sup> / 325 x 185 x 180 mm (Overall Depth With Bracket: 9 <sup>5/16</sup> / 235.4 mm)
Power Handling (RMS)	80 W	100 W
Impedance	8 ohms	8 ohms
Driver Size & Technology	5 <sup>1/2</sup> " C-CAM driver 1" C-CAM Gold Dome tweeter Rear mounted ABR (Auxiliary bass radiator)	6 <sup>1/2</sup> " C-CAM driver 1" C-CAM Gold Dome tweeter Rear mounted ABR (Auxiliary bass radiator)
IP Ratings	IP55	IP55

Climate 80

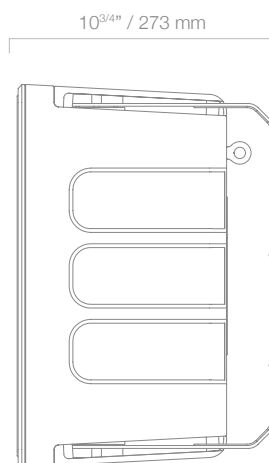

Climate 60-T2

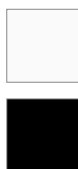
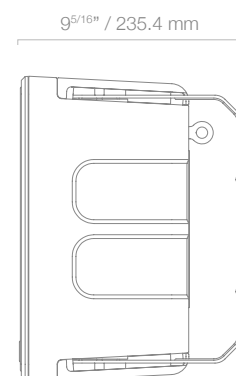

Finishes  
Textured White  
and Black

Sensitivity (1W@1m)	89.5 dB	88 dB
Overall Dimensions With Grille (H x W x D)	15 <sup>15/16</sup> x 9 <sup>1/16</sup> x 8 <sup>12/16</sup> / 405 x 230 x 221.5 mm (Overall Depth With Bracket: 10 <sup>3/4</sup> / 273 mm)	12 <sup>13/16</sup> x 7 <sup>5/16</sup> x 7 <sup>2/16</sup> / 325 x 185 x 180 mm (Overall Depth With Bracket: 9 <sup>5/16</sup> / 235.4 mm)
Power Handling (RMS)	120 W	2 x 50 W
Impedance	8 ohms	8 + 8 ohms
Driver Size & Technology	8" C-CAM driver 1" C-CAM gold dome tweeter Rear mounted ABR (Auxiliary bass radiator)	6 <sup>1/2</sup> " C-CAM driver 2 x 1" C-CAM Gold Dome tweeters T2: Stereo with double tweeter Rear mounted ABR (Auxiliary bass radiator)
IP Ratings	IP55	IP55

# Climate Garden System

The Climate Garden System comprises of super discreet all weather satellite speakers and a subwoofer. It's ground level installation amongst shrubs and trees delivers a luxury blend of unobtrusive aesthetics and natural full range audio in gardens of any size. 70/100 V line arrays of up to twelve satellites per subwoofer makes the Climate Garden System expandable with additional satellite and subwoofer sets according to garden area. Operating temperature range: -4° to 158° F / -20° to 70° C.



## In-Ground / Mounted

CLG140



CLG160

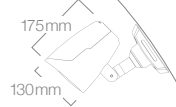
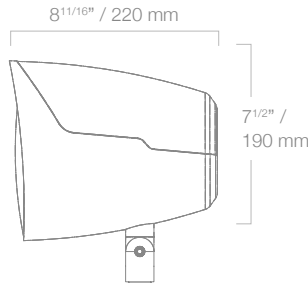
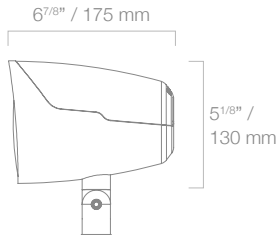

CLG-MOUNT

NOTE : Mount and Spike sold separately. Speakers not included. Tree or pole mounting possible with additional fixings.

CLG-SPIKE R

Sensitivity (1W@1m)	88 dB	89 dB
Overall Dimensions Excluding Mount/ Spike (H x W)	5 <sup>1</sup> / <sub>8</sub> x 6 <sup>7</sup> / <sub>8</sub> / 130 x 175 mm	7 <sup>1</sup> / <sub>2</sub> x 8 <sup>11</sup> / <sub>16</sub> / 190 x 220 mm
Power Handling (RMS)	40 W (Crossover set to minimum 100 Hz @ 12 dB/Octave)	60 W (Crossover set to minimum 80 Hz @12 dB/Octave)
Impedance	70/100 V line level	70/100 V line level
Driver Size & Technology	4" MMPII cone bass-mid driver 1" C-CAM Gold Dome tweeter – Coaxially oriented	6" MMPII cone bass-mid driver 1" C-CAM Gold Dome tweeter – Coaxially oriented
IP Ratings	IP55	IP55

CLG-W12 Subwoofer

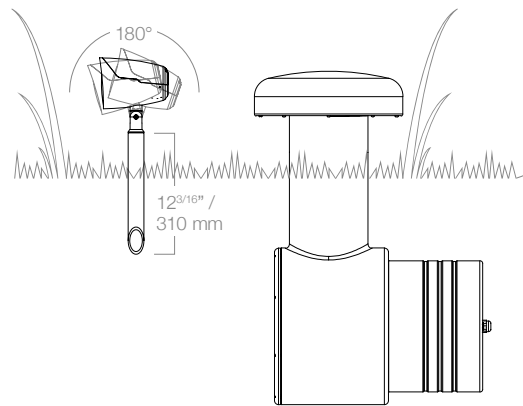
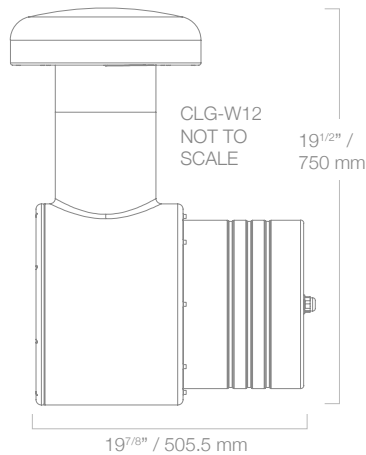

Sensitivity (1W@1m)	87 dB
Overall Dimensions (H x W x D)	19 <sup>1</sup> / <sub>2</sub> x 14 <sup>15</sup> / <sub>16</sub> x 19 <sup>7</sup> / <sub>8</sub> / 750 x 380 x 505.5 mm
Power Handling (RMS)	250 W
Impedance	4 ohms or 70/100 V line level (cable select)
Driver Size & Technology	12" C-CAM cone, long throw sub-bass driver
IP Ratings	IP54



CLG-W12 below ground garden installation. On patios or decks install within a suitably sized planter

# Custom Subwoofers

## Free Standing

The ultra-compact CW8 and CW10 are designed to generate deep bass impact with high output from easy-to-hide enclosures.

CW8



CW10



	CW8	CW10
Input Impedance	> 20 K ohms	> 20 K ohms
Cabinet Dimensions (H x W x D)	10 <sup>5/8</sup> x 10 <sup>1/4</sup> x 10 <sup>7/8</sup> " 270 x 260 x 276 mm	12 <sup>3/8</sup> x 12 x 12 <sup>5/8</sup> " 315 x 305 x 320 mm
Driver Size	8" C-CAM long throw driver 2 x 8" ABRs	10" C-CAM long throw driver 2 x 10" ABRs
Technology	Two, side mounted ABRs (Auxiliary bass radiators) to increase output and reduce distortion Tuned for High SPL and impact High power digital Class-D amplifier delivering over 400 W RMS IR sensor for remote control (Published feature codes) RS-232 for integration with system controllers (Published feature code) USB P.C. application for full feature adjustment and installer set-up LFE Balanced XLR Input and unbalanced RCA Stereo RCA line level inputs Phase and power mode switches Auto standby (signal sensing) and 12 V trigger 4 pre-set EQ's optimised for: Flat, Music, Movie and Impact with customisation using application Robust metal mesh grille Rigid MDF cabinet construction with durable vinyl finish	
Amplifier Power Output	350 W RMS @ < 1% THD+N	400 W RMS @ < 1% THD+N
Amplifier Classification	Class D amplifier with switch mode power supply (SMPSU)	Class D amplifier with switch mode power supply (SMPSU)

## In-Ceiling

ICS-8



ICS-8 is a high performance subwoofer, designed to fit into discreet spaces, such as ceiling and wall cavities. It's been developed primarily to complement the CF230 Flush Fit (Page 19) to delivering powerful bass where a full range system is required. The 8" driver has been angled internally in the rigid MDF enclosure, to reduce the overall box height and ensure compatibility with a wide range of standard construction cavities. It can be installed in ceiling, underfloor or suitable cavities and is designed to complement flush fit downlighting systems. Sealed bandpass enclosure design stops ingress of dirt and building materials. Delivering powerful bass down to 40Hz.

Sensitivity (1W@1m)	85 dB
Overall Cabinet Dimensions (H x W x L):	9 <sup>1/4</sup> x 11 x 15 <sup>9/16</sup> " 235 x 280 x 396 mm
Power handling	150 W – Full range – IEC268-5 rating
Impedance (nominal)	8 ohms
Driver Size & Technology	8" long throw bass driver, featuring C-CAM cone technology
Pre-Construction Bracket	CFB3-R (round grille) or CFB3-SQ (square grille) Pre-construction bracket included in above kits

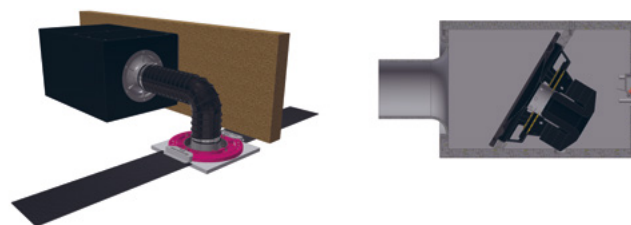

CFB3-R Flush Fit round grille

CFB3-SQ Flush Fit square grille

### Pre-Construction Flush Fit Brackets

The ICS-8 is installed using one of the brackets featured below.



CFB3-R (round)



CFB3-SQ (square)

Installation Guide video available, scan the QR code or visit:

[vimeo.com/monitoraudio/ics8](https://vimeo.com/monitoraudio/ics8)

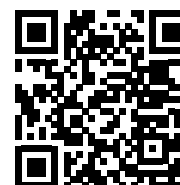

# Custom Subwoofers

## In-Wall

The In-Wall Subwoofer design is an amalgam of sophisticated IWS-10 subwoofer driver, IWA-250 amplifier and IWB-10 back box. The IWS-10 is specified to produce excellent bass quality in a range of wall, ceiling, even floor locations, ideally but not exclusively with its IWB-10 back box.



### IWS-10

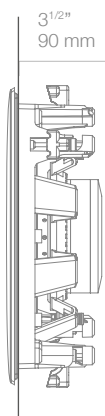

Sensitivity (1W@1m)	86 dB
Cut Out Dimensions (H x W)	11 x 11" / 280 x 280 mm
Mounting Depth	3 1/2" / 90 mm
Power Handling (RMS)	150 W
Impedance	8 ohms
Driver Size & Technology	10" C-CAM RDT driver Less than 4" mounting depth Ideally but not exclusively pairs with its IWB-10 back box Patented Tri-Grip mounting clamps
Back Box	IWB-10 (In-Wall Back Box)

### IWB-10 (In-Wall Back Box)



3 1/32"  
85 mm



IWB-10 shown with installed IWS-10 and grille

Overall Dimensions (H x W x D) :  
33 1/2" x 13 13/16" x 3 11/32" / 850 x 351 x 85 mm  
Internal volume 16.5 L  
Designed to provide optimum performance for IWS-10  
Fits into standard 14" stud bays (16" centres)  
Reduces the radiation of sound to adjacent rooms  
Heavy duty MDF construction  
Rugged laminated vinyl finish  
Pre-wired with external high quality push type terminals  
Supplied with mounting brackets for installation

## IWA-250 Amplifier

### IWA-250



Input Impedance	> 20 K ohms
Overall Dimensions (H x W x D):	1 3/4" x 17" x 10 3/8" 43.7 x 432 x 263 mm
Technology	Heavy-duty 1U rack mount case Will power single or dual IWS-10s Switch mode power supply DSP controlled with advanced limiters <0.5 W standby power consumption (ErP certified) DC short circuit protection, over-current and thermal protection Supplied with rack mounting brackets for installation
Amplifier Power Output	250 W @ < 1% THD+N
Amplifier Classification	Class D amplifier with Switch mode power supply (SMPSU)

The IWA-250 switch mode amplifier – a slim, powerful design in a heavy-duty 1U rack mount case. Delivering up to 250 W into 4 ohms, a single IWA-250 will power single or dual IWS-10s to provide higher power levels for larger rooms or to meet customer demands. The IWA-250 has input signal sensing, or is triggered from an AVR or other system source.



### CLG-W12

There is a subwoofer available for the Climate Garden System.  
Please view Page 29 for full details.



# Amplifiers

AVAILABLE  
February 2018

Introducing the Monitor Audio Installation Amplifiers, built to do more and use less space, featuring cutting-edge technology for the best sound performance in any installation project. The multi-channel amplifiers can be used in a wide range of applications in residential and commercial properties with power up to 2000 watts. Audio channels can be grouped or bridged for flexible installations, configurable to 1,2,3,6,8 or 12 channels. We have selected the world renowned Hypex amplifiers to guarantee reliability and the great sound quality you'd expect from Monitor Audio, reduced into slim 1U and 2U high cases that universally fit into most racks whilst delivering 93% energy efficiency. Auto ranging allows for use in any territory without the need for a separate power supply. The amplifier names all begin with 'IA' for Installation Amplifier, followed by their power in watts per channel at 4 ohms, the number of channels and a 'C' if it's IP connected. Installation amplifiers to suit any project.



There are two types on amplifiers in the range;

Distribution amplifiers – Full connectivity with simple wired voltage trigger or signal sense

Connected 'Connect' amplifiers with more complex DSP and IP control included – Offering wider flexibility and integration

## Distribution Amplifiers

IA150-2



IA60-12



'Connect' IP control	No	No
Channel Number	2 (1 Stereo Pair)	12 (6 Stereo Pairs)
Power (W / Channel)	4 ohms	150
	8 ohms	100
	Bridge (8 ohms)	320 (1CH)
	70V	N/A
Input Impedance	20 K ohms	20 K ohms
Output Impedance (Loop RCA)	600 ohms	600 ohms
Input Sensitivity	100 mV / 1 W, 990 mV – Full power	100 mV / 1 W, 650 mV – Full power
Rack Height	1U	2U
Dimensions (Without feet) (H x W x D)	1 <sup>11/16</sup> x 17 <sup>1/4</sup> x 16 <sup>13/16</sup> "	3 <sup>7/16</sup> x 17 <sup>1/4</sup> x 16 <sup>13/16</sup> "
	42.4 x 438 x 427 mm	86.8 x 438 x 427 mm
Height (With feet)	2 <sup>1/16</sup> " / 52.8 mm	3 <sup>13/16</sup> " / 97.2 mm
Width (Including rack brackets)	19 <sup>3/16</sup> " / 488 mm	19 <sup>3/16</sup> " / 488 mm



# 'Connect' Amplifiers

## 'Connect' IP interface

IA800-2C / IA200-2C / IA150-8C

Our 'Connect' IP interface is a web application, which can be accessed by any device connected to the internet with a web browser on the same network. This will allow the installer to set features and fine tune audio performance remotely from the amplifier location. The installer can therefore be in the same room as the speakers when performing these tasks.

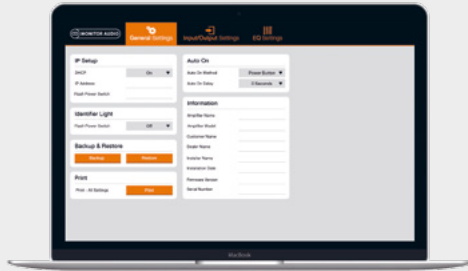

## IA800-2C



'Connect' IP control	Yes	
Channel Number	2 (1 Stereo Pair)	
Power (W / Channel)	4 ohms	800
	8 ohms	500
	Bridge (8 ohms)	2000 (1CH)
	70V	750 W/PC
Input Impedance	20 K ohms	
Output Impedance (Loop RCA)	600 ohms	
Input Sensitivity	100 mV / 1 W, 2200 mV – Full power	
Rack Height	2U	
Dimensions (Without feet) (H x W x D)	3 <sup>7/16</sup> x 17 <sup>1/4</sup> x 16 <sup>13/16</sup> "	
	86.8 x 438 x 427 mm	
Height (With feet)	3 <sup>13/16</sup> / 97.2 mm	
Width (Including rack brackets)	19 <sup>3/16</sup> / 488 mm	

## IA200-2C



## IA150-8C



'Connect' IP control	Yes		Yes	
Channel Number	2 (1 Stereo Pair)		8 (4 Stereo Pairs)	
Power (W / Channel)	4 ohms	225	150	
	8 ohms	150	130	
	Bridge (8 ohms)	470 (1CH)	300 (4CH)	
	70V	N/A	N/A	
Input Impedance	20 K ohms		20 K ohms	
Output Impedance (Loop RCA)	600 ohms		600 ohms	
Input Sensitivity	100 mV / 1 W, 1230 mV – Full power		100 mV / 1 W, 1140 mV – Full power	
Rack Height	1U		1U	
Dimensions (Without feet) (H x W x D)	1 <sup>11/16</sup> x 17 <sup>1/4</sup> x 16 <sup>13/16</sup> "		1 <sup>11/16</sup> x 17 <sup>1/4</sup> x 16 <sup>13/16</sup> "	
	42.4 x 438 x 427 mm		42.4 x 438 x 427 mm	
Height (With feet)	2 <sup>1/16</sup> / 52.8 mm		2 <sup>1/16</sup> / 52.8 mm	
Width (Including rack brackets)	19 <sup>3/16</sup> / 488 mm		19 <sup>3/16</sup> / 488 mm	

## Features – All Amplifiers

- Power Switch – Front panel mounted
- Status LED – Indicating standby, power on or protect modes
- Signal LED's – Indicating a signal is present at each channel independently. It will also indicate clipping
- Power Options – Trigger input – 3 – 30 V AC or DC. A trigger output supplies provides signal for additional amplifiers or other equipment.
  - Audio – Auto signal sensing or permanently on
- Speaker Connections – Industry standard removable block connectors accepts up to 12 gauge (3.5 mm2) cable

## Additional Features – Distribution Amplifiers

- Volume Level Controls – Each channel on the amplifier has a volume adjustment on the rear panel
- IA150-2 – Both Line Inputs and Loop Outputs – To connect other amplifiers/equipment
- IA60-12 – Buss Inputs A/B and loop Outputs – Loop outputs are non buffered (maximum number of amplifiers that can be looped together will depend on the output capability of your source component)

## Additional Features – 'Connect' Amplifiers

- Higher power levels
- Volume Level Controls – Each channel on the amplifier has a volume adjustment on the front panel
- 'Connect' – IP control is via the RJ-45 input. IP controls power On/Off, volume, muting and input source selections for either global control or group control
- IR Control – In/Out jacks. IR controls global On/Off, group volume, muting and input source selections. Connectivity can be seen with IR status light
- IA800-2C – Can drive 70 V line speakers directly without a line matching transformer

# Soundbars



## Active Soundbar

### Free Standing / On-Wall

Expertly engineered to re-energise HD and UHD pictures with the rich, detailed, immersive sound you've been missing. Your experience of TV is about to be transformed with this 2.0 Active Soundbar. Four Class D amplifiers, Digital wireless 2.4 GHz transmitter, Dolby Digital, Dolby Pro-Logic II and Dolby Virtual speaker.

#### ASB-10



Power Handling (RMS)	Bass/Mid-range: 2 x 30 W Tweeter: 2 x 20 W
Driver Size & Technology	4 x 3" C-CAM metal cone bass mid-range drivers 2 x 1 C-CAM Gold Dome tweeters 2 x ABRs (Auxiliary bass radiator) Compact dimensions for easy positioning beneath the TV, on-wall or cabinet location
Dimensions (H x W x D)	7 <sup>1/16</sup> x 39 <sup>9/16</sup> x 6 <sup>9/16</sup> " / 180 x 1005 mm x 167 mm
Amplifier Category	Class D
Suitable for display sizes	All



ASB-10 shown above with optional WS-10 active subwoofer and the WT-1 transmitter and WR-1 receiver wireless links. Find out more at [monitoraudio.com](http://monitoraudio.com)

# Passive Soundbars

## Free Standing / On-Wall

Add big sound to your big TV display without filling the room with speakers. Monitor Audio's Soundbars will complete your HD picture entertainment with the high definition sound, and match the look of your TV with contemporary lifestyle design. Can be wall mounted (Bracket sold separately).



SB-3 shown without outer cloth

SB-2 – 50" – 60" Screens



SB-3 – 60"+ Screens



SB-4 – 70"+ Screens



	SB-2	SB-3	SB-4
Sensitivity (1W@1m)	84 dB	Left and Right Channels: 84 dB Centre Channel: 87 dB	87 dB
Power Handling (RMS)	40 W	Left and Right Channels: 40 W Centre Channel: 80 W	80 W
Driver Size & Technology	3 x 4" C-CAM cone bass/mid drivers 3 x 1" C-CAM Gold Dome tweeters 3 x ABRs (Auxiliary bass radiator) Loading	4 x 4" C-CAM cone bass/mid drivers 3 x 1" C-CAM Gold Dome tweeters 4 x ABRs (Auxiliary bass radiator) Loading	6 x 4" C-CAM cone bass/mid drivers 3 x 1" C-CAM Gold Dome tweeters 4 x ABRs (Auxiliary bass radiator) Loading
Dimensions (H x W x D)	5 <sup>11/16</sup> x 43 <sup>11/16</sup> x 3 <sup>1/2</sup> " 145 x 1110 x 89 mm	5 <sup>11/16</sup> x 51 <sup>9/16</sup> x 3 <sup>1/2</sup> " 145 x 1310 x 89 mm	5 <sup>3/4</sup> x 61 <sup>1/2</sup> x 3 <sup>1/2</sup> " 145 x 1562 x 88 mm
Suitable for display sizes	50" – 60"	60"+	70"+
On-Wall Bracket (optional)	BSB	BSB	BSB

# SoundFrames

## In-Wall / On-Wall

The SoundFrame range provides the elusive blend of superior sound and décor that all style-conscious home entertainment lovers seek. They are easy to install with On-Wall and In-Wall options, pivoting drivers for the ideal audio balance, and a wide range of grille colours, images and custom grille designs. Keyhole fixings for On-Wall and pre-fix corner brackets for the In-Wall models make the process routine, and for a brilliant wire-free look, the connecting cable runs in the wall cavity, enters from the back and is connected at the front.

SoundFrame 1



SoundFrame 2



SoundFrame 3



Sensitivity (1W@1m)	86 dB	86 dB	85 dB
In-Wall Cut Out Dimensions (H x W)	19 <sup>11/16</sup> x 13 <sup>3/4</sup> " 501 x 351 mm	29 <sup>1/2</sup> x 7 <sup>7/8</sup> " 751 x 201 mm	9 <sup>7/8</sup> x 9 <sup>7/8</sup> " 251 x 251 mm
In-Wall Mounting Depth	2 <sup>15/16</sup> " / 75 mm	2 <sup>15/16</sup> " / 75 mm	2 <sup>5/16</sup> " / 59.5 mm
In-Wall Overall Dimensions (H x W x D)	21 <sup>3/4</sup> x 15 <sup>13/16</sup> x 3 <sup>1/2</sup> " / 552 x 402 x 88.25 mm	31 <sup>5/8</sup> x 9 <sup>15/16</sup> x 3 <sup>7/16</sup> " / 802.5 x 252.5 x 87.5 mm	11 <sup>7/8</sup> x 11 <sup>7/8</sup> x 3 <sup>1/16</sup> " / 301.5 x 301.5 x 77.5 mm
On-Wall Overall Dimensions (H x W x D)	21 <sup>1/4</sup> x 15 <sup>3/8</sup> x 3 <sup>7/16</sup> " 540 x 390 x 87.5 mm	31 <sup>1/8</sup> x 9 <sup>7/16</sup> x 3 <sup>7/16</sup> " 790 x 240 x 87.5 mm	11 <sup>3/8</sup> x 11 <sup>3/8</sup> x 3" 289 x 289 x 77.5 mm
Power Handling (RMS)	100 W	100 W	50 W
Impedance	8 ohms	8 ohms	8 ohms
Driver Size & Technology	6 <sup>1/2</sup> " C-CAM RST driver Pivoting IDC module (4" C-CAM RST inverted mid-range driver, 1" C-CAM Gold Dome tweeter) HF Control	6 <sup>1/2</sup> " C-CAM RST driver Pivoting IDC module (4" C-CAM RST inverted mid-range driver, 1" C-CAM Gold Dome tweeter) HF Control	4" C-CAM driver 1" C-CAM pivoting Gold Dome tweeter

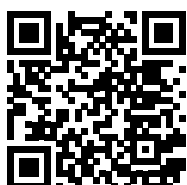

Explanation video available,  
scan the QR code or visit:  
[vimeo.com/monitoraudio/soundframe](https://vimeo.com/monitoraudio/soundframe)

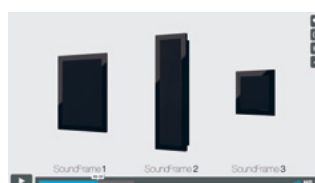

# SoundFrames

## In-Wall

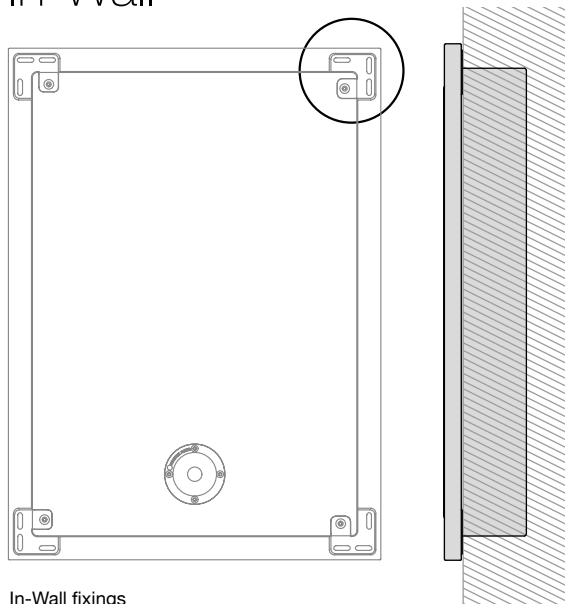

**In-Wall fixings**  
Product fixed into wall using corner brackets

## On-Wall

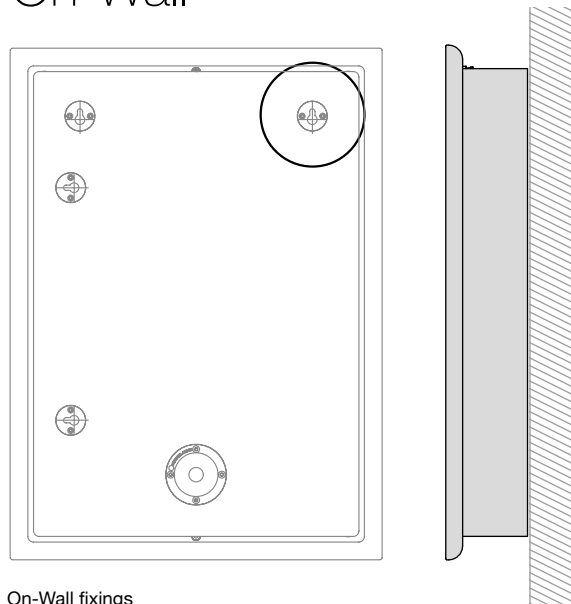

**On-Wall fixings**  
Product hangs on wall via keyhole fixings

## Grille removed



## Exploded view

Frame and grille attached using pegs and sockets



Cabinet

Frame

Grille

## Vertical or horizontal orientation



When ordering your SoundFrame state if you require the In-Wall or On-Wall options. Order Black Gloss or White Gloss finish.



**Finishes**  
Black Gloss and  
White Gloss

# Customise your SoundFrame Grilles

Standard grilles can be customised by purchasing replacement artwork from our extensive library of images or flat colours to match any décor. Or if the customer prefers they can provide a bespoke image of their choosing which can be printed and mounted onto a grille to fit any of the three sizes of SoundFrame. Both these options can also be created using our larger Frameless grilles where the outer frame is also removed.



Option 1:  
Library Grille



Fine art artwork example

Option 2:  
Bespoke Grille



Bespoke image on SoundFrame 1

Options 1 & 2:  
Frameless Grilles



Black Frameless grille

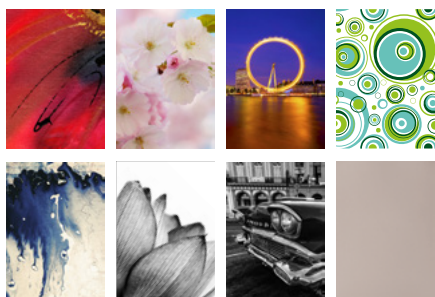

Small selection of our library grilles available, for the full selection please visit:  
[monitoraudio.co.uk/products/soundframe/grille-options](http://monitoraudio.co.uk/products/soundframe/grille-options)



Bespoke image on SoundFrame 2



Library image  
Frameless grille



Bespoke image  
Frameless grille

Please contact your local dealer to place an order for a bespoke grille. There are file specifications in place to achieve best results please only use high resolution images.

The larger frameless grilles replace both the grille and frame to give the impression of an edgeless image. Plain Black or White options available.

When ordering your customised SoundFrame grille, state which image you require, which size of SoundFrame and if you prefer the framed or frameless option.

# Accessories

## Pre-Construction Brackets

Pre-Construction brackets are available for speakers as an accessory to help mark speaker placement during framing and prior to sheetrock application. The brackets will span up to 24" stud spacing. Pre-Construction brackets are not required for retrofit applications.

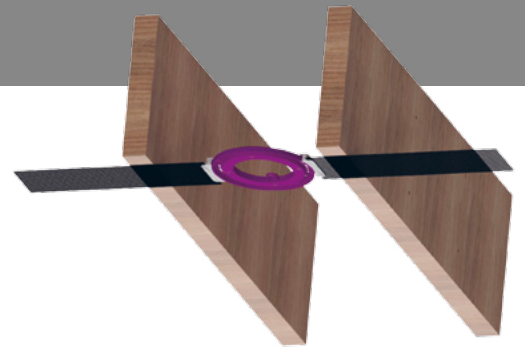



### In-Ceiling Pre-Construction Brackets

<b>CB4</b> 	<b>CB4</b>	<b>Page</b>
	CS140	12

<b>CB5</b> 	<b>CB5</b>	<b>Page</b>
	CS160	12

<b>CB6</b> 	<b>CB6</b>	<b>Page</b>
	C165	8
	C165-T2	8
	C265	8
	C265-IDC	8
	C265-FX	8
	CS180	12
	CSS230	13
	CP-CT150	14
	AWC265	27
	AWC265-T2	27

<b>CB8</b> 	<b>CB8</b>	<b>Page</b>
	C180	9
	C180-T2	9
	C280	9
	C280-IDC	9
	C380-IDC	9
	C380-FX	9
	CP-CT260	14
	PRO-80	25
	AWC280	27
	AWC280-T2	27

<b>CB10</b> 	<b>CB10</b>	<b>Page</b>
	CP-CT380	14
	CP-CT380IDC	14
	PLIC II	23

<b>PRO-IC65</b>	<b>PRO-IC65</b>	<b>Page</b>
	PRO-65	25

<b>CB8-LV</b> 	<b>CB8-LV</b>	<b>Page</b>
	PRO-80LV	25

<b>CB8-LVK</b> 	<b>CB8-LVK</b>	<b>Page</b>
	PRO-80LV	25

### In-Wall Pre-Construction Brackets

<b>WB3</b> 	<b>WB3</b>	<b>Page</b>
	WSS130	13
	WSS230	13
	WSS430	13

<b>WB6</b> 	<b>WB6</b>	<b>Page</b>
	W165	10
	W265	10
	CP-WT150	15

<b>WB8</b> 	<b>WB8</b>	<b>Page</b>
	W180	11
	W280	11
	W280-IDC	11
	W380-IDC	11
	CP-WT260	15

<b>WB10</b> 	<b>WB10</b>	<b>Page</b>
	CP-WT380	15
	CP-WT380IDC	15

<b>WB12</b> 	<b>WB12:</b>	<b>Page</b>
	CP-IW260X	16
	CP-IW460X	17

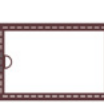
<b>WB4LCR</b> 	<b>WB4LCR</b>	<b>Page</b>
	CP-WT140LCR	16
	CP-WT240LCR	16

<b>WB5LCR</b> 	<b>WB5LCR</b>	<b>Page</b>
	W150-LCR	10
	W250-LCR	10

### On-Wall Bracket

<b>BSB</b> 	<b>BSB (Soundbars)</b>	<b>Page</b>
	SB-2	35
	SB-3	35
	SB-4	35

# Back Boxes

## In-Ceiling Concrete

### CCBOX-R



Overall dimensions:  
13 x 13 x 4<sup>15/16</sup>" / 330 x 330 x 125 mm  
Internal depth (max.): 4<sup>1/2</sup>" / 115 mm  
Internal volume 6.31 L

### CCBOX-L



Overall dimensions:  
13 x 13 x 6<sup>1/2</sup>" / 330 x 330 x 165 mm  
Internal depth (max.): 6<sup>1/8</sup>" / 155 mm  
Internal volume 8.9 L

Prior to pouring a concrete ceiling the CCBOX-R (regular) or CCBOX-L (large) allows you to create a placeholder ready for In-Ceiling speakers to be installed. They are lightweight and at the same time offers a robust stability with excellent shock absorption features. Three cut out sizes offer unlimited possibilities, with two side cut outs allow for best possible handling of electronic ductwork (20 mm + 25 mm). Better insulation with airborne and structure-borne noise compared to conventional In-Ceiling systems. Concrete rings and installation components provided so that all conventional speaker systems will fit perfectly.

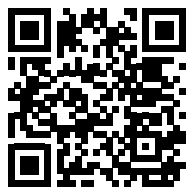

Installation Guide video available, scan the QR code or visit:

[vimeo.com/monitoraudio/ccbox](https://vimeo.com/monitoraudio/ccbox)



## In-Wall Concrete

### WCBOX-L



Overall dimensions:  
23<sup>1/4</sup> x 17<sup>1/8</sup> x 4<sup>3/4</sup>" /  
590 x 435 x 120 mm  
Internal depth (max.):  
4<sup>1/8</sup>" / 105 mm  
Cut out dimensions:  
15<sup>1/4</sup> x 9<sup>3/16</sup>" / 387 x 234 mm  
Internal volume 14.8 L

The WCBOX-L (large) allows you to install In-Wall speakers into concrete or brick walls. With the front and rear Fermacell boards, the WCBOX-L will seamlessly integrate into your installation workflow, enabling a quick and easy processing of the walls surface. The body material is framed by EPS to achieve low resonances and improved sound insulation features. The WCBOX-L is lightweight and at the same time offers a robust stability with excellent shock absorption features.



Installation Guide video available, scan the QR code or visit:

[vimeo.com/monitoraudio/wcbox](https://vimeo.com/monitoraudio/wcbox)

## In-Ceiling MDF

### CMBOX-R



Overall dimensions:  
11<sup>13/16</sup> x 13<sup>3/4</sup> x 6<sup>5/16</sup>" /  
300 x 350 x 160 mm  
Internal volume 12.2 L

The CMBOX-R (regular) is a Back Box made of MDF, which allows you to install speakers from our Core, Slim and All Weather ranges into the ceiling. Comes with Small and Large Ring (fitted) adapters, which can also be removed.



No Ring 250 mm

Large Ring (Fitted) 218 mm

Small Ring 173 mm

Accessories Images Not To Scale

### In-Ceiling Concrete

CCBOX-R	
Models	Page
C165	8
C165-T2	8
C180	9
C180-T2	9
C265	8
C280	9
CS140	12
CS160	12
CS180	12
AWC265	27
AWC265-T2	27
AWC280	27
AWC280-T2	27

CCBOX-L	
Models	Page
C265-IDC	8
C265-FX	8
CP-CT150	14
CP-CT260	14

### In-Wall Concrete

WCBOX-L	
Models	Page
W180	11
W280	11
W280-IDC	11
W380-IDC	11
CP-WT260	15

### In-Ceiling MDF

CMBOX-R	
No Ring	Page
C180	9
C180-T2	9
C280	9
C280-IDC	9
C380-IDC	9
C380-FX	9
AWC280	27
AWC280-T2	27
Large Ring (Fitted)	Page
C165	8
C165-T2	8
C265	8
C265-IDC	8
C265-FX	8
CS180	12
AWC265	27
AWC265-T2	27
Small Ring	Page
CS160	12



# Back Boxes

## Product Back Boxes

### Platinum In-Ceiling II Back Box



Overall Dimensions (Including Brackets):  
 $7\frac{1}{2} \times 24\frac{3}{4} \times 13\frac{3}{4}$ " / 191.2 x 628.6 x 350 mm  
 Internal volume 24 L

#### PLIC-BOX II

To ensure controlled audio performance for the PLIC II, Monitor Audio has designed an optional pre-construction MDF back box with pre-determined air volume of 24 L. The rigid box is available with pre-loaded internal damping material to provide the best possible sound absorption and reduce standing waves.

[See Page 23 for more details.](#)

### In-Wall Subwoofer Back Box

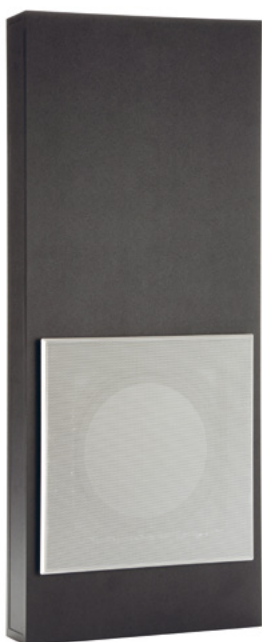

IWB-10 shown with installed IWS-10 and grille

Overall Dimensions (H x W x D) :  
 $33\frac{1}{2} \times 13\frac{13}{16} \times 3\frac{1}{32}$ " / 850 x 351 x 85 mm  
 Internal volume 16.5 L

#### IWB-10 (In-Wall Box)

- Designed to provide optimum performance for IWS-10
- Fits into standard 14" stud bays (16" centres)
- Reduces the radiation of sound to adjacent rooms
- Heavy duty MDF construction
- Rugged laminated vinyl finish
- Pre-wired with external high quality push type terminals
- Supplied with mounting brackets for installation

[See Page 31 for more details.](#)

## Square Grilles

All-round performance in a square.  
 Designed to suit contemporary interior styling, our alternative square grilles are available for numerous In-Ceiling speakers shown below.



### Square grilles

Core	Page
C165	8
C165-T2	8
C265	8
C265-IDC	8
C265-FX	8
C180	9
C180-T2	9
C280	9
C280-IDC	9
C380-IDC	9
C380-FX	9
<b>Super Slim</b>	
CSS230	13
<b>Controlled Performance</b>	
CP-CT150	14
CP-CT260	14
CP-CT380	14
CP-CT380IDC	14
<b>Platinum II</b>	
PLIC II	23
<b>All Weather</b>	
AWC265	27
AWC265-T2	27
AWC280	27
AWC280-T2	27



**NOTE :** All Slim models can be ordered as round or square grille options. See Page 12.



# SPECIFICATIONS

These specifications are supplied to aid installers to select which product is the best fit for their project.

All Monitor Audio Custom Install products have CAD files available, ideal for architectural drawings.

These can be found along with individual product or range information on our website. [Click on a product to find out more.](#)

Category	Core In-Ceiling										
Application	In-Ceiling										
Model Name	<b>C165</b>	<b>C165-T2</b>	<b>C265</b>	<b>C265-IDC</b>	<b>C265-FX</b>	<b>C180</b>	<b>C180-T2</b>	<b>C280</b>	<b>C280-IDC*</b>	<b>C380-IDC*</b>	<b>C380-FX</b>
Page	8	8	8	8	8	9	9	9	9	9	9
Sensitivity (1W@1m)	88.5 dB	88.5 dB	88.5 dB	88.5 dB	88.5 dB	90 dB	90 dB	90 dB	90 dB	90 dB	90 dB
Cut Out Diameter	8 <sup>1/8"</sup> / 211 mm	8 <sup>1/8"</sup> / 211 mm	8 <sup>1/8"</sup> / 211 mm	8 <sup>1/8"</sup> / 211 mm	8 <sup>1/8"</sup> / 211 mm	9 <sup>3/16"</sup> / 247 mm	9 <sup>3/16"</sup> / 247 mm	9 <sup>3/16"</sup> / 247 mm	9 <sup>3/16"</sup> / 247 mm	9 <sup>3/16"</sup> / 247 mm	9 <sup>3/16"</sup> / 247 mm
Mounting Depth	4 <sup>1/2"</sup> / 114 mm	4 <sup>1/2"</sup> / 114 mm	4 <sup>1/2"</sup> / 114 mm	4 <sup>1/2"</sup> / 114 mm	5 <sup>7/8"</sup> / 149 mm	4 <sup>3/4"</sup> / 121 mm	4 <sup>3/4"</sup> / 121 mm	4 <sup>3/4"</sup> / 121 mm	6 <sup>1/8"</sup> / 156 mm	6 <sup>1/8"</sup> / 156 mm	6 <sup>1/8"</sup> / 156 mm
Overall Depth (With Grille)	4 <sup>5/8"</sup> / 118 mm	4 <sup>5/8"</sup> / 118 mm	4 <sup>5/8"</sup> / 118 mm	6" / 153 mm	6" / 153 mm	4 <sup>15/16"</sup> / 125 mm	4 <sup>15/16"</sup> / 125 mm	4 <sup>15/16"</sup> / 125 mm	6 <sup>5/16"</sup> / 160 mm	6 <sup>5/16"</sup> / 160 mm	6 <sup>5/16"</sup> / 160 mm
Overall Diameter (With Grille)	9 <sup>13/16"</sup> / 250 mm	9 <sup>13/16"</sup> / 250 mm	9 <sup>13/16"</sup> / 250 mm	9 <sup>13/16"</sup> / 250 mm	9 <sup>13/16"</sup> / 250 mm	11 <sup>1/4"</sup> / 285 mm	11 <sup>1/4"</sup> / 285 mm	11 <sup>1/4"</sup> / 285 mm	11 <sup>1/4"</sup> / 285 mm	11 <sup>1/4"</sup> / 285 mm	11 <sup>1/4"</sup> / 285mm
Power Handling (RMS)	65 W	65 W	75 W	85 W	85 W	120 W	120 W	120 W	120 W	150 W	120 W
Impedance	6 ohms	6 + 6 ohms	6 ohms	6 ohms	6 ohms	6 ohms	6 + 6 ohms	6 ohms	6 ohms	6 ohms	6 ohms
Driver Size & Technology	6 <sup>1/2"</sup> MMP II driver 1" C-CAM tweeter	6 <sup>1/2"</sup> MMP II driver 2 x 1" C-CAM tweeters	6 <sup>1/2"</sup> C-CAM driver 1" C-CAM tweeter	6 <sup>1/2"</sup> C-CAM driver 4" C-CAM RST driver 1" C-CAM tweeter	6 <sup>1/2"</sup> C-CAM driver 2 x 1" C-CAM tweeters	8" MMP II driver 1" C-CAM tweeter	8" MMP II driver 2 x 1" C-CAM tweeters	8" C-CAM driver 1" C-CAM tweeter	8" C-CAM driver 4" C-CAM RST driver 1" C-CAM tweeter	8" C-CAM RST driver 4" C-CAM RST driver 1" C-CAM tweeter	8" C-CAM RST driver 2 x 1" C-CAM tweeters
Frequency Response	60 Hz – 25 kHz	60 Hz – 25 kHz	60 Hz – 30 kHz	60 Hz – 30 kHz	60 Hz – 30 kHz	50 Hz – 25 kHz	50 Hz – 25 kHz	50 Hz – 30 kHz	50 Hz – 30 kHz	45 Hz – 30 kHz	45 Hz – 30 kHz
Maximum SPL	107.4 dBA	107.9 dBA	108 dBA	108 dBA	108 dBA	111.6 dBA	111.6 dBA	111.6 dBA	111.6 dBA	112 dBA	111.6 dBA
Recommended Amp Requirements	20 – 65 W	20 – 65 W	20 – 75 W	20 – 85 W	20 – 85 W	30 – 120 W	30 – 120 W	30 – 120 W	30 – 120 W	40 – 150 W	30 – 120 W
Optional Square Grilles	Yes	Yes	Yes	Yes	Yes	Yes	Yes	Yes	Yes	Yes	Yes
Feature	-	T2	-	IDC	FX	-	T2	-	IDC	IDC	FX
HF Level Switch (+3 dB/0 dB/-3 dB)	Yes	-	Yes	Yes	Yes	Yes	Yes	Yes	Yes	Yes	Yes
Boundary Compensation Switch	-	-	Yes	Yes	-	-	-	Yes	Yes	Yes	-
Bipole/ Dipole Switch	-	-	-	-	Yes	-	-	-	-	-	Yes Additional 12 V Trigger Switching
Construction Material	Mineral filled ABS plastic, RoHS2 Compliant	Mineral filled ABS plastic, RoHS2 Compliant	Mineral filled ABS plastic, RoHS2 Compliant	Mineral filled ABS plastic, RoHS2 Compliant	Mineral filled ABS plastic, RoHS2 Compliant	Mineral filled ABS plastic, RoHS2 Compliant	Mineral filled ABS plastic, RoHS2 Compliant	Mineral filled ABS plastic, RoHS2 Compliant	Mineral filled ABS plastic, RoHS2 Compliant	Mineral filled ABS plastic, RoHS2 Compliant	Mineral filled ABS plastic, RoHS2 Compliant
Weight	4 lb 4 oz 1.92 kg	4 lb 10 oz 2.08 kg	4 lb 8 oz 2.04 kg	6 lb 10 oz 2.54 kg	4 lb 10 oz 2.08 kg	6 lb 2.72 kg	6 lb 2 oz 3 kg	6 lb 2 oz 2.8 kg	7 lb 8 oz 3.42 kg	8 lb 3.64 kg	7 lb 3.2 kg
Pre-Construction Bracket	CB6 (Purple)	CB6 (Purple)	CB6 (Purple)	CB6 (Purple)	CB6 (Purple)	CB8 (Green)	CB8 (Green)	CB8 (Green)	CB8 (Green)	CB8 (Green)	CB8 (Green)
Back Box	COBOX-R / CMBOX-R	CCBOX-R / CMBOX-R	CCBOX-R / CMBOX-R	CCBOX-L / CMBOX-R	CCBOX-L / CMBOX-R	CCBOX-R / CMBOX-R	CCBOX-L / CMBOX-R	CCBOX-L / CMBOX-R	CMBOX-R	CMBOX-R	CMBOX-R

Category	Core In-Wall							
Application	In-Wall							
Model Name	<b>W150-LCR</b>	<b>W250-LCR</b>	<b>W165</b>	<b>W265</b>	<b>W180</b>	<b>W280</b>	<b>W280-IDC</b>	<b>W380-IDC</b>
Page	10	10	10	10	11	11	11	11
Sensitivity (1W@1m)	88 dB	88 dB	88.5 dB	88.5 dB	90 dB	90 dB	90 dB	90 dB
Cut Out Dimensions (H x W)	5 <sup>3/4"</sup> x 13 <sup>7/8"</sup> 145 x 353 mm	5 <sup>3/4"</sup> x 13 <sup>7/8"</sup> 145 x 353 mm	13 <sup>1/16"</sup> x 8 <sup>3/8"</sup> 332 x 213 mm	13 <sup>1/16"</sup> x 8 <sup>3/8"</sup> 332 x 213 mm	15 <sup>1/4"</sup> x 9 <sup>3/16"</sup> 387 x 234 mm	15 <sup>1/4"</sup> x 9 <sup>3/16"</sup> 387 x 234 mm	15 <sup>1/4"</sup> x 9 <sup>3/16"</sup> 387 x 234 mm	15 <sup>1/4"</sup> x 9 <sup>3/16"</sup> 387 x 234 mm
Mounting Depth	4" / 100.2 mm	4" / 100.2 mm	3 <sup>9/8"</sup> / 85.5 mm	3 <sup>9/8"</sup> / 85.5 mm	3 <sup>11/16"</sup> / 93 mm	3 <sup>11/16"</sup> / 93 mm	3 <sup>11/16"</sup> / 93 mm	3 <sup>13/16"</sup> / 97.5 mm
Overall Depth (With Grille)	4 <sup>1/8"</sup> / 105 mm	4 <sup>1/8"</sup> / 105 mm	3 <sup>1/2"</sup> / 89.5 mm	3 <sup>1/2"</sup> / 89.5 mm	3 <sup>13/16"</sup> / 97.5 mm	3 <sup>13/16"</sup> / 97.5 mm	3 <sup>13/16"</sup> / 97.5 mm	4" / 101.5 mm
Overall Dimensions (With Grille) (H x W)	7 x 15 <sup>3/16"</sup> 177.4 x 385.2 mm	7 x 15 <sup>3/16"</sup> 177.4 x 385.2 mm	14 <sup>9/16"</sup> x 9 <sup>13/16"</sup> 370 x 250 mm	14 <sup>9/16"</sup> x 9 <sup>13/16"</sup> 370 x 250 mm	17 <sup>3/8"</sup> x 11 <sup>5/16"</sup> 441 x 288 mm	17 <sup>3/8"</sup> x 11 <sup>5/16"</sup> 441 x 288 mm	17 <sup>3/8"</sup> x 11 <sup>5/16"</sup> 441 x 288 mm	17 <sup>3/8"</sup> x 11 <sup>5/16"</sup> 441 x 288 mm
Power Handling (RMS)	100 W	100 W	65 W	65 W	120 W	120 W	150 W	150 W
Impedance	8 ohms	8 ohms	6 ohms	6 ohms	6 ohms	6 ohms	6 ohms	6 ohms
Driver Size & Technology	2 x 5" MMP II drivers 1" C-CAM tweeter	2 x 5" C-CAM drivers 1" C-CAM tweeter	6 <sup>1/2"</sup> MMP II driver 1" C-CAM tweeter	6 <sup>1/2"</sup> C-CAM driver 1" C-CAM tweeter	8" MMP II driver 1" C-CAM tweeter	8" C-CAM driver 1" C-CAM tweeter	8" C-CAM driver 1" C-CAM tweeter	8" C-CAM RST driver 4" C-CAM RST driver 1" C-CAM tweeter
Frequency Response	60 Hz – 30 kHz	60 Hz – 30 kHz	60 Hz – 25 kHz	55 Hz – 30 kHz	50 Hz – 25 kHz	45 Hz – 30 kHz	45 Hz – 30 kHz	45 Hz – 30 kHz
Maximum SPL	108 dBA	108 dBA	107.4 dBA	107.4 dBA	111.6 dBA	111.6 dBA	111.6 dBA	112 dBA
Recommended Amp Requirements	30 – 100 W	30 – 100 W	20 – 65 W	20 – 65 W	30 – 120 W	30 – 120 W	40 – 150 W	40 – 150 W
Feature	LCR	LCR	-	-	-	-	IDC	IDC
HF Level Switch (+3 dB/0 dB/-3 dB)	-	Yes	Yes	Yes	Yes	Yes	Yes	Yes
MF Level Switch (+3 dB/0 dB/-3 dB)	-	-	-	-	-	-	-	Yes
Boundary Compensation Switch	-	-	-	Yes	-	Yes	Yes	Yes
Construction Material	Mineral filled ABS plastic, RoHS2 Compliant	Mineral filled ABS plastic, RoHS2 Compliant	Mineral filled ABS plastic, RoHS2 Compliant	Mineral filled ABS plastic, RoHS2 Compliant	Mineral filled ABS plastic, RoHS2 Compliant	Mineral filled ABS plastic, RoHS2 Compliant	Mineral filled ABS plastic, RoHS2 Compliant	Mineral filled ABS plastic, RoHS2 Compliant
Weight	8 lb 3oz / 3.76 kg	8 lb 4 oz / 3.80 kg	4 lb 14 oz / 2.21 kg	5 lb / 2.26 kg	6 lb 12 oz / 3.08 kg	6 lb 14 oz / 3.1 kg	7 lb 14 oz / 3.6 kg	9 lb / 4.1 kg
Pre-Construction Bracket	WB5LCR (Yellow)	WB5LCR (Yellow)	WB6 (Purple)	WB6 (Purple)	WB8 (Green)	WB8 (Green)	WB8 (Green)	WB8 (Green)
Back Box	-	-	-	-	WCBOX-L	WCBOX-L	WCBOX-L	WCBOX-L

## Plasterboard/Sheetrock maximum mounting thickness

This table shows the maximum mounting thickness of the plasterboard/Sheetrock required for Monitor Audio Custom Install products.

Most products unless stated below	1 <sup>3/16"</sup> / 30 mm
In-Ceiling IDC*	1 <sup>15/16"</sup> / 50 mm
Super Slim**	9/16" / 15 mm



# SPECIFICATIONS

Category	Slim			Super Slim				
Application	In-Ceiling / In-Wall			In-Ceiling	In-Wall			
Model Name	CS140 Round/Square	CS160 Round/Square	CS180 Round/Square	CSS230**	WSS130**	WSS230**	WSS430**	
Page	12	12	12	13	13	13	13	
Sensitivity (1W@1m)	85 dB	88 dB	90 dB	86 dB	87 dB	87 dB	87 dB	
Cut Out Diameter or Dimensions (H x W)	5 <sup>7/8</sup> " 149 mm	6 <sup>11/16</sup> " 170 mm	6 <sup>3/8</sup> " 213 mm	8 <sup>1/4</sup> " 211 mm	13 <sup>1/2</sup> " x 4" 346 x 101 mm	13 <sup>1/2</sup> " x 4" 346 x 101 mm	13 <sup>1/2</sup> " x 4" 346 x 101 mm	
Mounting Depth	3 <sup>7/8</sup> " / 99 mm	3 <sup>7/8</sup> " / 99 mm	3 <sup>15/16</sup> " / 99.4 mm	2" / 50 mm	2" / 50 mm	2" / 50 mm	2" / 50 mm	
Overall Depth (With Grille)	4 <sup>1/16</sup> " 103.4 mm	4 <sup>1/16</sup> " 102.8 mm	4 <sup>1/16</sup> " 103.3 mm	2 <sup>1/8</sup> " 54 mm	2 <sup>1/8</sup> " 54.25 mm	2 <sup>1/8</sup> " 54.25 mm	2 <sup>1/8</sup> " 54.25 mm	
Overall Diameter or Dimensions (With Grille) (H x W)	Round: 7 <sup>1/8</sup> " / 180.2 mm Square: 6 <sup>15/16</sup> " x 6 <sup>15/16</sup> " / 176.7 x 176.7 mm	Round: 8 <sup>1/16</sup> " / 204.2 mm Square: 7 <sup>13/16</sup> " x 7 <sup>13/16</sup> " / 199.2 x 199.2 mm	Round: 9 <sup>5/16</sup> " / 251.7 mm Square: 9 <sup>1/16</sup> " x 9 <sup>1/16</sup> " / 246.7 x 246.7 mm	9 <sup>13/16</sup> " 250 mm	15 x 5 <sup>1/2</sup> " 385 x 140.5 mm	15 x 5 <sup>1/2</sup> " 385 x 140.5 mm	15 x 5 <sup>1/2</sup> " 385 x 140.5 mm	15 x 5 <sup>1/2</sup> " 385 x 140.5 mm
Power Handling (RMS)	50 W	70 W	120 W	40 W – Full range 60 W – Crossover set to 100 Hz @ 12 dB/Octave	60 W – Full range 100 W – Crossover set to 100 Hz @ 12 dB/Octave	60 W – Full range 100 W – Crossover set to 100 Hz @ 12 dB/Octave	75 W – Full range 120 W – Crossover set to 100 Hz @ 12dB/Octave	
Impedance	6 ohms	6 ohms	6 ohms	8 ohms	8 ohms	8 ohms	8 ohms	
Driver Size & Technology	4" MMP II driver 1" C-CAM tweeter	6" MMP II driver 1" C-CAM tweeter	8" MMP II driver 1" C-CAM tweeter	3 x 3" C-CAM drivers 3 <sup>3/4</sup> " C-CAM tweeter	3 x 3" MMP II drivers 1" C-CAM tweeter	3 x 3" C-CAM drivers 1" C-CAM tweeter	3 x 3" C-CAM drivers MPD HF transducer	
Frequency Response	75 Hz – 30 kHz	60 Hz – 30 kHz	48 Hz – 30 kHz	100 Hz – 30kHz (Sealed CP) 85 Hz – 30kHz (Open back)	100 Hz – 30 kHz	75 Hz – 30 kHz	70 Hz – 50 kHz	
Maximum SPL	102.8 dBA	107.2 dBA	110.6 dBA	103.8 dBA	105.6 dBA	105.6 dBA	106.5 dBA	
Recommended Amp Requirements	10 – 50 W	15 – 70 W	30 – 120 W	10 – 60 W	10 – 100 W	10 – 100 W	10 – 120 W	
Optional Square Grilles	Order Round or Square	Order Round or Square	Order Round or Square	Yes	-	-	-	
Construction Material	Mineral filled ABS plastic, RoHS2 Compliant	Mineral filled ABS plastic, RoHS2 Compliant	Mineral filled ABS plastic, RoHS2 Compliant	Mineral filled ABS plastic, RoHS2 Compliant	Mineral filled ABS Plastic, RoHS2 Compliant	Mineral filled ABS Plastic, RoHS2 Compliant	Mineral filled ABS Plastic, RoHS2 Compliant	
Weight	2 lb 10 oz / 1.18 kg	4 lb 6 oz / 2.10 kg	6 lb 2 / 2.72 kg	6 lb 5 oz / 2.88 kg	3 lb 2 oz / 1.4 kg	3 lb 2 oz / 1.4 kg	2 lb 6 oz / 1.1 kg	
Pre-Construction Bracket	CB4 (Pink)	CB5 (Blue)	CB6 (Purple)	CB6 (Purple)	WB3 (Dark blue)	WB3 (Dark blue)	WB3 (Dark blue)	
Back Box	CCBOX-R	CCBOX-R / CMBOX-R	CCBOX-R / CMBOX-R	-	-	-	-	

Category	Controlled Performance												
Application	In-Ceiling						In-Wall						In-Ceiling
Model Name	CP-CT150	CP-CT260	CP-CT380	CP-CT380 IDC	CP-WT150	CP-WT260	CP-WT380	CP-WT380 IDC	CP-WT140 LCR	CP-WT240 LCR	CP-IW260X	CP-IW460X	CPC120
Page	14	14	14	14	15	15	15	15	16	16	16	17	18
Sensitivity (1W@1m)	85 dB	88 dB	89 dB	89 dB	85 dB	88 dB	89 dB	89 dB	88 dB	88 dB	89 dB	89 dB	85 dB
Cut Out Diameter or Dimensions (H x W)	8 <sup>3/8</sup> " 212 mm	9 <sup>5/8</sup> " 244 mm	10 <sup>13/16</sup> " 274 mm	10 <sup>13/16</sup> " 274 mm	12 <sup>13/16</sup> " x 8 <sup>1/8</sup> " 326 x 207 mm	15 x 9" 381 x 228 mm	17 <sup>1/4</sup> " x 10 <sup>9/16</sup> " 438 x 269 mm	17 <sup>1/4</sup> " x 10 <sup>9/16</sup> " 438 x 269 mm	7 <sup>3/16</sup> " x 11 <sup>3/4</sup> " 183 x 299 mm	7 <sup>3/16</sup> " x 11 <sup>3/4</sup> " 183 x 299 mm	34 <sup>21/32</sup> " x 9" 880 x 230 mm	34 <sup>21/32</sup> " x 9" 880 x 230 mm	2 <sup>1/2</sup> " 65 mm
Mounting Depth	5 <sup>15/16</sup> " 151 mm	5 <sup>15/16</sup> " 151 mm	7 <sup>1/8</sup> " 181 mm	7 <sup>1/8</sup> " 181 mm	3 <sup>3/4</sup> " 96 mm	3 <sup>3/4</sup> " 96 mm	3 <sup>7/8</sup> " 99 mm	3 <sup>7/8</sup> " 99 mm	3 <sup>13/16</sup> " 97 mm	3 <sup>13/16</sup> " 97 mm	3 <sup>3/4</sup> " 96 mm	3 <sup>3/4</sup> " 96 mm	3 <sup>5/8</sup> " 91.5 mm
Overall Depth (With Grille)	6 <sup>1/8</sup> " 155 mm	6 <sup>1/8</sup> " 155 mm	7 <sup>3/8</sup> " 187 mm	7 <sup>3/8</sup> " 187 mm	4" 102 mm	4" 102 mm	4 <sup>1/8</sup> " 106 mm	4 <sup>3/16</sup> " 106 mm	4 <sup>1/16</sup> " 103 mm	4 <sup>1/16</sup> " 103 mm	4" 102 mm	4" 102 mm	4" 96 mm
Overall Diameter or Dimensions (With Grille) (H x W)	9 <sup>13/16</sup> " 250 mm	11 <sup>1/4</sup> " 285 mm	12 <sup>3/16</sup> " 309 mm	12 <sup>3/16</sup> " 309 mm	14 <sup>3/16</sup> " x 9 <sup>1/2</sup> " 360.5 x 242 mm	16 <sup>5/16</sup> " x 10 <sup>5/16</sup> " 415 x 262.5 mm	18 <sup>5/8</sup> " x 11 <sup>15/16</sup> " 472.5 x 303.5 mm	18 <sup>5/8</sup> " x 11 <sup>15/16</sup> " 472.5 x 303.5 mm	8 <sup>9/16</sup> " x 13 <sup>1/16</sup> " 217 x 333 mm	8 <sup>9/16</sup> " x 13 <sup>1/16</sup> " 217 x 333 mm	35 <sup>3/4</sup> " x 10 <sup>1/8</sup> " 907 x 257 mm	35 <sup>3/4</sup> " x 10 <sup>1/8</sup> " 907 x 257 mm	3 <sup>1/8</sup> " 80mm
Power Handling (RMS)	50 W	65W	120 W	120 W	50 W	65 W	120 W	120 W	100 W	100 W	150 W	150 W	20 W 50 W using crossover @ 200 Hz
Impedance	6 ohms	6 ohms	6 ohms	6 ohms	6 ohms	6 ohms	6 ohms	6 ohms	6 ohms	6 ohms	6 ohms	6 ohms	8 ohms
Driver Size & Technology	5" MMP II driver 1" C-CAM tweeter	6" C-CAM driver 1" C-CAM tweeter	8" C-CAM RST driver 1" C-CAM tweeter	8" C-CAM RST driver 4" C-CAM IDC driver 1" C-CAM tweeter	5" MMP II driver 1" C-CAM tweeter	6" C-CAM driver 1" C-CAM tweeter	8" C-CAM RST driver 1" C-CAM tweeter	8" C-CAM RST driver 4" C-CAM IDC driver 1" C-CAM tweeter	2 x 4" MMP II drivers 1" C-CAM tweeter	2 x 4" C-CAM drivers 1" C-CAM tweeter	2 x 6 <sup>1/2</sup> " C-CAM drivers 2 x 4" C-CAM drivers 1" C-CAM tweeter	2 x 6 <sup>1/2</sup> " C-CAM RST drivers 2 x 4" C-CAM RST drivers HF ribbon transducer	2" micro driver
Frequency Response	75 Hz – 25 kHz	66 Hz – 25 kHz	50 Hz – 25 kHz	50 Hz – 30 kHz	75 Hz – 25 kHz	65 Hz – 25 kHz	50 Hz – 25 kHz	50 Hz – 30 kHz	60 Hz – 25 kHz	60 Hz – 25 kHz	50 Hz – 30 kHz	50 Hz – 60 kHz	100 Hz – 20 kHz
Maximum SPL	102.8 dBA	106.9 dBA	109.6 dBA	109.6dBA	102.8 dBA	106.9 dBA	109.6 dBA	109.6 dBA	108.8 dBA	108.8 dBA	113.8 dBA	113.8 dBA	101.9 dBA
Recommended Amp Requirements	20 – 50 W	20 – 65 W	30 – 120 W	30 – 120W	20 – 50 W	20 – 65 W	30 – 120 W	30 – 120 W	20 – 100 W	20 – 100 W	60 – 150 W	60 – 150 W	5 – 20 W 5 – 50 W using a crossover
Optional Square Grilles	Yes	Yes	Yes	Yes	-	-	-	-	-	-	-	-	-
Feature	-	-	-	IDC	-	-	-	IDC	LCR	LCR	Full Size	Full Size	Micro
HF Level Switch (+3 dB/0 dB/-3 dB)	Yes	Yes	Yes	Yes	Yes	Yes	Yes	Yes	Yes	Yes	Yes (+1/0/-1 dB)	Yes (+1/0/-1 dB)	-
MF Level Switch (+3 dB/0 dB/-3 dB)	-	-	-	Yes	-	-	-	Yes	-	-	Yes (+1/0/-1 dB)	Yes (+1/0/-1 dB)	-
Boundary Compensation Switch	-	Yes	Yes	Yes	-	Yes	Yes	Yes	-	Yes	Yes	Yes	-
Construction Material	Mineral filled ABS plastic, RoHS2 Compliant	Mineral filled ABS plastic, RoHS2 Compliant	Mineral filled ABS plastic, RoHS2 Compliant	Mineral filled ABS plastic, RoHS2 Compliant	Mineral filled ABS plastic, RoHS2 Compliant	Mineral filled ABS plastic, RoHS2 Compliant	Mineral Filled ABS plastic / Die-Cast Aluminium Baffle, RoHS2 Compliant	Mineral Filled ABS plastic / Die-Cast Aluminium Baffle, RoHS2 Compliant	Mineral filled ABS plastic, RoHS2 Compliant	Mineral filled ABS plastic, RoHS2 Compliant	Mineral filled ABS plastic, RoHS2 Compliant	Cast Polymer / Die-Cast Aluminium Baffle, RoHS2 Compliant	Steel Bezel / Aluminium Enclosure
Weight	4 lb 12 oz / 2.14 kg	6 lb 2 oz / 2 kg	8 lb 4 oz / 3.74 kg	9 lb 8 oz / 4.3 kg	5 lb 14 oz / 2.65 kg	7 lb 4 oz / 3.31 kg	10 lb 14 oz / 4.95 kg	12 lb 6 oz / 5.62 kg	5 lb 8 oz / 2.5 kg	5 lb 8 oz / 2.5 kg	26 lb 6 oz / 11.98 kg	28 lb 6 oz / 12.98 kg	7 oz / 0.19 kg
Pre-Construction Bracket	CB6 (Purple)	CB8 (Green)	CB10 (Light brown)	CB10 (Light brown)	WB6 (Purple)	WB8 (Green)	WB10 (Light brown)	WB10 (Light brown)	WB4LCR (Dark brown)	WB4LCR (Dark brown)	WB12 (Green)	WB12 (Green)	-
Back Box	CCBOX-L	CCBOX-L	-	-	-	WCBOX-L	-	-	-	-	-	-	-



# SPECIFICATIONS

Category	Flush Fit	Invisible	PLATINUM II		Pro		
Application	In-Ceiling	In-Wall	In-Ceiling	In-Wall	In-Ceiling		
Model Name	<b>CF230</b>	<b>IV140</b>	<b>PLIC II</b>	<b>Platinum In-Wall II</b>	<b>PRO-65</b>	<b>PRO-80</b>	<b>PRO-80LV</b>
Page	19	20 – 21	23	24	25	25	25
Sensitivity (1W@1m)	82.5 dB	82 dB (when installed as directed)	90 dB	90 dB	86 dB	87 dB	87 dB
Cut Out Diameter or Dimensions (H x W)	Flush Fit 4 <sup>3/4"</sup> / 120 mm Retrofit 3 <sup>9/16"</sup> / 90 mm	23 <sup>1/4"</sup> x 13 <sup>3/16"</sup> 591 x 350.5 mm	10 <sup>3/4"</sup> 273 mm	46 <sup>7/16"</sup> x 11 <sup>7/8"</sup> 1179 x 302 mm	8 <sup>1/16"</sup> 205 mm	9 <sup>3/4"</sup> 248 mm	10 <sup>1/2"</sup> 266 mm
Mounting Depth	3 <sup>5/16"</sup> / 83.5 mm	3 <sup>13/16"</sup> / 83.5 mm	7 <sup>5/16"</sup> / 185 mm	3 <sup>14/16"</sup> / 97.5 mm	3 <sup>7/16"</sup> / 87.7 mm	3 <sup>7/8"</sup> / 98.1 mm	4" / 101.4 mm
Overall Depth (With Grille)	3 <sup>5/16"</sup> 83.62 mm	3 <sup>3/4"</sup> 95.5 mm	7 <sup>1/2"</sup> 191.5 mm	4 <sup>7/16"</sup> 105.5 mm	3 <sup>11/16"</sup> 92.7 mm	4 <sup>1/16"</sup> 103 mm	4 <sup>8/16"</sup> 114 mm
Overall Diameter or Dimensions (With Grille) (H x W)	4 <sup>7/16"</sup> 112 mm	25 <sup>1/4"</sup> x 15 <sup>13/16"</sup> 642 x 401.5 mm	12 <sup>3/16"</sup> 309 mm	47 <sup>9/16"</sup> x 13 <sup>1/16"</sup> 1207 x 332 mm	9 <sup>5/16"</sup> 232.5 mm	10 <sup>3/4"</sup> 273 mm	11 <sup>9/16"</sup> 294 mm
Power Handling (RMS)	30 W – Full range – IEC268-5 rating 100 W – Music program (Using High Pass crossover filter @120 Hz)	50 W – Full range – IEC268-5 rating 100 W – Music program (Using Minimum 80 Hz High Pass filter)	150 W	200 W	30 W	40 W	40 W
Impedance	8 ohms	8 ohms	4 ohms Nominal (3.1 ohms minimum @ 1.1 kHz)	4 ohms (3.7 ohms min. @ 2.8 kHz)	8 ohms	8 ohms	16 ohms 70 V (4, 8, 16, 32, 64 W) / 100 V (8, 16, 32, 64 W) power selection
Driver Size & Technology	3 <sup>1/2"</sup> Bass/mid-range C-CAM driver 3 <sup>4"</sup> C-CAM Gold Dome tweeter	1 x LF transducer 2 x HF transducers	8" RDT II bass driver 2 x 2" C-CAM mid-range drivers MPD HF transducer	2 x 6 <sup>1/2"</sup> RDT II drivers 4" RDT II driver MPD HF transducer	6 <sup>1/2"</sup> MMP II driver 1" fabric soft dome tweeter	8" MMP II driver 1" fabric soft dome tweeter	8" MMP II driver 1" C-CAM tweeter
Frequency Response	100 Hz – 25 kHz	75 Hz – 18 kHz (CP sealed) 55 Hz – 18 kHz (Open back)	45 Hz – 60 kHz	52 Hz – 100 kHz	75 Hz – 20 kHz	60 Hz – 20 kHz	65 Hz – 25 kHz
Maximum SPL	98 dBA (Each – Full range) 103.3 dBA (Each – Using crossover)	102.8 dBA	112 dBA	117 dBA (pair)	101.5 dBA	103.8 dBA	103.8 dBA
Recommended Amp Requirements	10 – 30 W (Full range) 10 – 100 W (Using High Pass crossover filter @120 Hz)	20 – 50 W (Full range) 20 – 100 W (Using Minimum 80 Hz High Pass filter)	50 – 150 W	100 – 200 W	10 – 30 W	10 – 40 W	10 – 40 W
Optional Square Grilles	-	-	Yes	-	-	-	-
Feature	-	-	-	-	-	-	- LINE VOLTAGE
HF Level Switch (+1dB/0dB/-1dB)	-	-	Yes	Yes	-	-	-
MF Level Switch (+1dB/0dB/-1dB)	-	-	Yes	Yes	-	-	-
Construction Material	Mineral filled ABS plastic, RoHS2 Compliant	MDF	Mineral filled ABS plastic, RoHS2 Compliant, Die cast Aluminium	25 mm MDF with steel back	Mineral filled ABS plastic, RoHS2 Compliant	Mineral filled ABS plastic, RoHS2 Compliant	Mineral filled ABS plastic, RoHS2 Compliant / Steel rear enclosure
Weight	1 lb / 0.44 kg	20 lb / 9 kg	11 lb 10 oz / 5.3 kg	59 lb 8 oz / 27 kg	4 lb 2 oz / 1.86 kg	5 lb 5 oz / 2.42 kg)	10 lb 11 oz / 4.85 kg
Pre-Construction Bracket	Flush Fit – CFB3-R (round) / CFB3-SQ (square). Pre-construction bracket included in above kits Retrofit – CFB3-KIT	WBIV140	CB10 (Light brown)	-	PRO-IC65 Construction Bracket	CB8 (Green)	CB8-LV CB8-LVK
Back Box	-	-	PLIC-BOX II or a bespoke sealed enclosure of 24 L	-	-	-	-

Category	All Weather				Climate				Climate Garden System		
Application	In-Ceiling				In-Ceiling				In-Ground / Mounted		Subwoofer
Model Name	<b>AWC265</b>	<b>AWC265-T2</b>	<b>AWC280</b>	<b>AWC280-T2</b>	<b>Climate 50</b>	<b>Climate 60</b>	<b>Climate 60-T2</b>	<b>Climate 80</b>	<b>CLG140</b>	<b>CLG160</b>	<b>CLG-W12</b>
Page	27	27	27	27	28	28	28	28	29	29	29
Sensitivity (1W@1m)	88 dB	88 dB (both channels driven)	89 dB	89 dB (both channels driven)	87 dB	88 dB	88 dB	89.5 dB	88 dB	89 dB	87 dB
Cut Out Diameter or Dimensions (H x W)	8 <sup>1/4"</sup> 211 mm	8 <sup>1/4"</sup> 211 mm	9 <sup>3/4"</sup> 247 mm	9 <sup>3/4"</sup> 247 mm	-	-	-	-	-	-	-
Mounting Depth	3 <sup>1/2"</sup> / 88.5 mm	3 <sup>1/2"</sup> / 88.5 mm	3 <sup>7/8"</sup> / 97.6 mm	3 <sup>7/8"</sup> / 97.6 mm	-	-	-	-	-	-	-
Overall Depth (With Grille)	3 <sup>1/2"</sup> 93.5 mm	3 <sup>1/2"</sup> 93.5 mm	4 <sup>1/32"</sup> 102.5 mm	4 <sup>1/32"</sup> 102.5 mm	6 <sup>5/16"</sup> 160 mm	7 <sup>2/16"</sup> 180 mm	7 <sup>2/16"</sup> 180 mm	8 <sup>12/16"</sup> 221.5 mm	-	-	-
Overall Depth (With Bracket)	-	-	-	-	8 <sup>5/16"</sup> 210.4 mm	9 <sup>5/16"</sup> 235.4 mm	9 <sup>5/16"</sup> 235.4 mm	10 <sup>3/4"</sup> 273 mm	-	-	-
Overall Diameter or Dimensions (With Grille) (H x W)	9 <sup>13/16"</sup> 251.7 mm	9 <sup>13/16"</sup> 251.7 mm	11 <sup>1/4"</sup> 285 mm	11 <sup>1/4"</sup> 285 mm	11 <sup>1/4"</sup> x 6 <sup>13/16"</sup> 285 x 172.5 mm	12 <sup>13/16"</sup> x 7 <sup>5/16"</sup> 325 x 185 mm	12 <sup>13/16"</sup> x 7 <sup>5/16"</sup> 325 x 185 mm	15 <sup>15/16"</sup> x 9 <sup>7/16"</sup> 405 x 230 mm	Excluding Mount/Spike 5 <sup>1/8"</sup> x 6 <sup>1/2"</sup> 130 x 175 mm	Excluding Mount/Spike 7 <sup>1/2"</sup> x 8 <sup>11/16"</sup> 190 x 220 mm	29 <sup>1/2"</sup> x 14 <sup>15/16"</sup> x 19 <sup>5/8"</sup> 750 x 380 x 505.5 mm
Power Handling (RMS)	60 W	60 W	100 W	2 x 50 W	80 W	100 W	2 x 50 W	120 W	40 W (Crossover set to minimum 100 Hz @ 12 dB/Octave)	60 W (Crossover set to minimum 80 Hz @ 12 dB/Octave)	250 W
Impedance	8 ohms 4.4 ohms @ 190 Hz	8 + 8 ohms 4.5 ohms @ 185 Hz	8 ohms 4.5 ohms @ 185 Hz	8 + 8 ohms 4.5 ohms @ 185 Hz	8 ohms	8 ohms	8 + 8 ohms	8 ohms	70/100 V line level	70/100 V line level	4 ohms or 70/100 V line level (cable select)
Driver Size & Technology	6 <sup>1/2"</sup> C-CAM driver 1" C-CAM tweeter	6 <sup>1/2"</sup> C-CAM driver 2 x 1" C-CAM tweeters	8" C-CAM driver 1" C-CAM tweeter	8" C-CAM driver 2 x 1" C-CAM tweeters	5 <sup>1/2"</sup> C-CAM driver 1" C-CAM tweeter ABR	6 <sup>1/2"</sup> C-CAM driver 1" C-CAM tweeter ABR	6 <sup>1/2"</sup> C-CAM driver 2 x 1" C-CAM tweeters ABR	8" C-CAM driver 1" C-CAM tweeter ABR	4" MMP II driver 1" C-CAM tweeter	6" MMP II driver 1" C-CAM tweeter	12" C-CAM bass driver
Frequency Response	60 Hz – 30 kHz	60 Hz – 30 kHz	50 Hz – 30 kHz	50 Hz – 30 kHz	75 Hz – 30 kHz	63 Hz – 30 kHz	63 Hz – 30 kHz	50 Hz – 30 kHz	100 Hz – 30 kHz	80 Hz – 30 kHz	30 Hz – 100 Hz
Maximum SPL	105.8 dBA	105.8 dBA	109 dBA	109 dBA	106.8 dBA	108.8 dBA	108.8 dBA	111.1 dBA	104 dBA	107 dBA	110 dBA
Recommended Amp Requirements	20 – 60 W	20 – 60 W	20 – 100 W	20 – 100 W	10 – 80 W	15 – 100 W	15 – 100 W	20 – 120 W	10 – 40 W per speaker	10 – 60 W per speaker	100 – 250 W
Optional Square Grilles	Yes	Yes	Yes	Yes	-	-	-	-	-	-	-
Feature	-	T2	-	T2	-	-	T2	-	-	-	-
HF Level Switch (+3 dB/0 dB/-3 dB)	Yes	Yes	Yes	Yes	-	-	-	-	-	-	-
Construction Material	Mineral Filled PC-ABS Polymer (UL V0 Fire Retardant, RoHS2 Compliant) SS430 Stainless Steel / Samarium Cobalt	Mineral Filled PC-ABS Polymer (UL V0 Fire Retardant, RoHS2 Compliant) SS430 Stainless Steel / Samarium Cobalt	Mineral Filled PC-ABS Polymer (UL V0 Fire Retardant, RoHS2 Compliant) SS430 Stainless Steel / Samarium Cobalt	Mineral Filled PC-ABS Polymer (UL V0 Fire Retardant, RoHS2 Compliant) SS430 Stainless Steel / Samarium Cobalt	High-density polypropylene enclosure / Aluminium grille	High-density polypropylene enclosure / Aluminium grille	High-density polypropylene enclosure / Aluminium grille	High-density polypropylene enclosure / Aluminium grille	Rigid, high impact cast polymer cabinet for long life and durability	Rigid, high impact cast polymer cabinet for long life and durability	High impact moulded cabinet – robust and waterproof
Weight	4 lb 12 oz / 2.14 kg	4 lb 12 oz / 2.14 kg	6 lb 2 oz / 2.8 kg	6 lb 2 oz / 2.8 kg	8 lb 1 oz / 3.66 kg	10 lb 3 oz / 4.62 kg	11 lb 1 oz / 5.02 kg	14 lb 6 oz / 6.53 kg	4 lb 10 oz / 2.08 kg	6 lb 2 oz / 2.76 kg	42 lb 14 oz / 19.5 kg
Operating temperature Range	-29° to 174° F -34° to 79° C	-29° to 174° F -34° to 79° C	-29° to 174° F -34° to 79° C	-29° to 174° F -34° to 79° C	-13° to 149° F -25° to 65° C	-13° to 149° F -25° to 65° C	-13° to 149° F -25° to 65° C	-13° to 149° F -25° to 65° C	-4° to 158° F / -20° to 70° C	-4° to 158° F / -20° to 70° C	-
IP Ratings	IP55	IP55	IP55	IP55	IP55	IP55	IP55	IP55	IP55	IP55	IP54
Pre-Construction Bracket	CB6 (Purple)	CB6 (Purple)	CB8 (Green)	CB8 (Green)	-	-	-	-	CLG-Mount / CLG-Spike R	CLG-Mount / CLG-Spike R	-
Back Box	COBOX-R / CMBOX-R	COBOX-R / CMBOX-R	CCBOX-R / CMBOX-R	CCBOX-R / CMBOX-R	-	-	-	-	-	-	-



Category	Custom Subwoofers				
Application	Free Standing		In-Ceiling	In-Wall	In-Rack
Model Name	CW8	CW10	ICS-8	IWS-10	IWA-250 Amplifier
Page	30	30	30	31	31
Sensitivity (1W@1m)	-	-	85 dB	86 dB	-
Cut Out Diameter or Dimensions (H x W)	-	-	4 <sup>3/4</sup> " 120 mm	11 x 11" 280 x 280 mm	-
Mounting Depth	-	-	-	3 <sup>1/2</sup> " / 90 mm	-
Overall Dimensions (With Grille) (H x W x D)	10 <sup>5/8</sup> x 10 <sup>1/4</sup> x 10 <sup>7/8</sup> " 270 x 260 x 276 mm	12 <sup>3/8</sup> x 12 x 12 <sup>5/8</sup> " 315 x 305 x 320 mm	9 <sup>1/4</sup> x 11 x 15 <sup>1/8</sup> " 235 x 280 x 396 mm	12 <sup>3/8</sup> x 12 <sup>3/8</sup> x 3 <sup>15/16</sup> " 314.21 x 314.21 x 100.78 mm	13 <sup>3/4</sup> x 17 x 10 <sup>3/8</sup> " 43.7 x 432 x 263 mm
Power Handling (RMS)	-	-	150 W – Full range – IEC268-5 rating	150 W	-
Impedance	-	-	8 ohms	8 ohms	-
Driver Size & Technology	8" C-CAM driver 2 x 8" ABRs	10" C-CAM driver 2 x 10" ABRs	8" C-CAM driver	10" C-CAM RDT driver	-
Frequency Response	-	-	40 Hz – 120 Hz	28 Hz – 120 Hz	25 Hz – 120 Hz
Maximum SPL	105.8 dBA	105.8 dBA	107 dB	Single unit 109.8 dB / Pair 115.8 dB	-
Amplifier Power Output	350 W RMS @ < 1% THD+N	400 W RMS @ < 1% THD+N	-	-	250 W @ <1% THD+N
Amplifier Classification	Class D amplifier with switch mode power supply (SMPSU)	Class D amplifier with switch mode power supply (SMPSU)	-	-	Class D amplifier with switch mode power supply (SMPSU)
Construction Material	18 mm MDF cabinet	18 mm MDF cabinet	15 mm MDF construction, vinyl laminate surface	Mineral Filled ABS Plastic (RoHS Compliant)	3 mm thick fabricated steel case, moulded ABS front trim panel
Weight	21 lb / 9.52 kg	27 lb 12 oz / 12.64 kg	22 lb 8 oz / 10.2 kg	8 lb 6 oz / 3.8 kg	8 lb 12 oz / 4 kg
Pre-Construction Bracket	-	-	CFB3-R (round) / CFB3-SQ (square). Pre-construction bracket included in above kits	-	-
Back Box	-	-	-	IWB-10 (In-Wall Back Box)	-

Category	Amplifiers				
Application	In-Rack				
Model Name	IA150-2	IA60-12	IA800-2C	IA200-2C	IA150-8C
Page	32	32	33	33	33
'Connect' IP control	-	-	Yes	Yes	Yes
Channel Number	2 (1 Stereo Pair)	12 (6 Stereo Pairs)	2 (1 Stereo Pair)	2 (1 Stereo Pair)	8 (4 Stereo Pairs)
Power (W / Channel)	4 ohms: 150 8 ohms: 100 Bridge (8 ohms): 320 (1CH) 70V: N/A	60 60 100 (6CH)	800 500 2000 (1CH) 750 W/PC	225 150 470 (1CH)	150 130 300 (4CH)
Input Impedance	20 K ohms	20 K ohms	20 K ohms	20 K ohms	20 K ohms
Output Impedance (Loop RCA)	600 ohms	600 ohms	600 ohms	600 ohms	600 ohms
Input Sensitivity	100 mV / 1 W, 990 mV – Full power	100 mV / 1 W, 650 mV – Full power	100 mV / 1 W, 2200 mV – Full power	100 mV / 1 W, 1230 mV – Full power	100 mV / 1 W, 1140 mV – Full power
Maximum Input Voltage	2.9 V	2.9 V	2.9 V	2.9 V	2.9 V
Signal to noise (SN:R)	-100 dB (20 Hz – 20 kHz)	-100 dB (20 Hz – 20 kHz)	-100 dB (20 Hz – 20 kHz)	-100 dB (20 Hz – 20 kHz)	-100 dB (20 Hz – 20 kHz)
Frequency Response	5 Hz – 50 kHz	5 Hz – 50 kHz	5 Hz – 50 kHz	5 Hz – 50 kHz	5 Hz – 50 kHz
Total Harmonic Distortion THD + N@1 KHz	0.1%	0.1%	0.30%	0.06%	0.10%
Rack Height	1U	2U	2U	1U	1U
Dimensions (Without feet) (H x W x D)	1 <sup>11/16</sup> x 17 <sup>1/4</sup> x 16 <sup>13/16</sup> " 42.4 x 438 x 427 mm	3 <sup>7/16</sup> x 17 <sup>1/4</sup> x 16 <sup>13/16</sup> " 86.8 x 438 x 427 mm	3 <sup>7/16</sup> x 17 <sup>1/4</sup> x 16 <sup>13/16</sup> " 86.8 x 438 x 427 mm	1 <sup>11/16</sup> x 17 <sup>1/4</sup> x 16 <sup>13/16</sup> " 42.4 x 438 x 427 mm	1 <sup>11/16</sup> x 17 <sup>1/4</sup> x 16 <sup>13/16</sup> " 42.4 x 438 x 427 mm
Height (With feet)	2 <sup>1/16</sup> " / 52.8 mm	3 <sup>13/16</sup> " / 97.2 mm	3 <sup>13/16</sup> " / 97.2 mm	2 <sup>1/16</sup> " / 52.8 mm	2 <sup>1/16</sup> " / 52.8 mm
Width (Including rack brackets)	19 <sup>3/16</sup> " / 488 mm	19 <sup>3/16</sup> " / 488 mm	19 <sup>3/16</sup> " / 488 mm	19 <sup>3/16</sup> " / 488 mm	19 <sup>3/16</sup> " / 488 mm
Weight	11 lb 10 oz / 5.29 kg	16 lb 5 oz / 7.34 kg	20 lb 4 oz / 9.2 kg	11 lb 10 oz / 5.3 kg	16 lb 6 oz / 7.45 kg
IP Communication	N/A	N/A	TCP/IP (RJ-45 10/100 Base T)	TCP/IP (RJ-45 10/100 Base T)	TCP/IP (RJ-45 10/100 Base T)
Mains Operating Voltage	100–120 V @ 60 Hz, 220 – 240 V @ 50 Hz	100–120 V @ 60 Hz, 220 – 240 V @ 50 Hz	100–120 V @ 60 Hz, 220 – 240 V @ 50 Hz	100–120 V @ 60 Hz, 220 – 240 V @ 50 Hz	100–120 V @ 60 Hz, 220 – 240 V @ 50 Hz
Fuse Rating	5 A (T5AL – 250VAC)	10 A (T10AL – 250VAC)	15 A (T15AL – 250VAC)	5 A (T5AL – 250VAC)	10 A (T10AL – 250VAC)
Standby power consumption	<0.5 W (green mode)	<0.5 W (green mode)	<0.5 W (green mode)	<0.5 W (green mode)	<0.5 W (green mode)

Category	Soundbars				SoundFrames					
Application	Active		Passive		In-Wall					
Model Name	ASB-10	SB-2	SB-3	SB-4	SoundFrame1	SoundFrame2	SoundFrame3	SoundFrame1	SoundFrame2	SoundFrame3
Page	34	35	35	35	36	36	36	36	36	36
Sensitivity (1W@1m)	-	84 dB	Left and Right Channels: 84 dB Centre Channel: 87 dB	87 dB	86 dB	86 dB	85dB	86 dB	86 dB	85 dB
Cut Out Dimensions (H x W)	-	-	-	-	19 <sup>11/16</sup> x 13 <sup>3/4</sup> " 501 x 351mm	29 <sup>1/2</sup> x 7 <sup>7/8</sup> " 751 x 201 mm	9 <sup>7/8</sup> x 9 <sup>7/8</sup> " 251 x 251 mm	-	-	-
Mounting Depth	-	-	-	-	2 <sup>15/16</sup> " / 75 mm	2 <sup>15/16</sup> " / 75 mm	2 <sup>5/16</sup> " / 59.5 mm	-	-	-
Overall Depth (With Grille)	6 <sup>9/16</sup> " 167 mm	3 <sup>1/2</sup> " 89 mm	3 <sup>1/2</sup> " 89 mm	3 <sup>1/2</sup> " 88 mm	3 <sup>1/2</sup> " 88.25 mm	3 <sup>7/16</sup> " 87.5 mm	3" 77.5 mm	3 <sup>7/16</sup> " 87.5 mm	3 <sup>7/16</sup> " 87.5 mm	3" 77.5 mm
Overall Dimensions (With Grille) (H x W)	7 <sup>11/16</sup> x 33 <sup>9/16</sup> " 180 x 1005 mm	5 <sup>11/16</sup> x 43 <sup>11/16</sup> " 145 x 1110 mm	5 <sup>11/16</sup> x 51 <sup>9/16</sup> " 145 x 1310 mm	5 <sup>3/4</sup> x 61 <sup>1/2</sup> " 145 x 1562 mm	21 <sup>3/4</sup> x 15 <sup>13/16</sup> " 552 x 402 mm	31 <sup>5/8</sup> x 9 <sup>15/16</sup> " 802.5 x 252.5 mm	11 <sup>7/8</sup> x 11 <sup>7/8</sup> " 301.5 x 301.5 mm	21 <sup>1/8</sup> x 15 <sup>3/8</sup> " 540 x 390 mm	31 <sup>1/8</sup> x 9 <sup>7/16</sup> " 790 x 240 mm	11 <sup>3/8</sup> x 11 <sup>3/8</sup> " 289 x 289 mm
Power Handling (RMS)	Bass/Mid-range: 2 x 30 W Tweeter: 2 x 20 W	40 W	Left and Right Channels: 40 W Centre Channel: 80 W	80 W	100 W	100 W	50 W	100 W	100 W	50 W
Impedance	-	8 ohms	8 ohms	8 ohms	8 ohms	8 ohms	8 ohms	8 ohms	8 ohms	8 ohms
Driver Size & Technology	4 x 3" C-CAM bass/mid drivers 2 x 1" C-CAM tweeters 2 x ABRs	3 x 4" C-CAM bass/mid drivers 3 x 1" C-CAM tweeters 3 x ABRs	4 x 4" C-CAM bass/mid drivers 3 x 1" C-CAM tweeters 4 x ABRs	6 x 4" C-CAM bass/mid drivers 3 x 1" C-CAM tweeters 4 x ABRs	6 <sup>1/2</sup> " C-CAM RST driver 4" C-CAM IDC driver 1" C-CAM tweeter	6 <sup>1/2</sup> " C-CAM RST driver 4" C-CAM IDC driver 1" C-CAM tweeter	4" MMP II driver 1" C-CAM tweeter	6 <sup>1/2</sup> " C-CAM RST driver 4" C-CAM IDC driver 1" C-CAM tweeter	6 <sup>1/2</sup> " C-CAM RST driver 4" C-CAM IDC driver 1" C-CAM tweeter	4" MMP II driver 1" C-CAM tweeter
Frequency Response	65 Hz – 20 kHz	90 Hz – 30 kHz	80 Hz – 30 kHz	70 Hz – 30 kHz	55 Hz – 35 kHz	55 Hz – 35 kHz	75 Hz – 35 kHz	55 Hz – 35 kHz	55 Hz – 35 kHz	75 Hz – 35 kHz
Maximum SPL	105 dBA (@ 1 m)	104 dBA (108.8 dBA all channels driven)	104 dBA (108.8 dBA all channels driven)	104 dBA (108.8 dBA all channels driven)	106 dBA	106 dBA	102.5 dBA	106 dBA	106 dBA	102.5 dBA
Recommended Amp Requirements	Class D	30 – 100 W	30 – 100 W	30 – 100 W	20 – 100 W	20 – 100 W	20 – 50 W	20 – 100 W	20 – 100 W	20 – 50 W
Construction Material	Moulded polymer cabinet	MDF	MDF	MDF	MDF	MDF	MDF	MDF	MDF	MDF
Weight	11 lb 5 kg	16 lb 12 oz 7.64 kg	20 lb 9.1 kg	26 lb 7 oz 12 kg	16 lb 10 oz 7.53 kg	16 lb 7.26 kg	6 lb 10 oz 3 kg	16 lb 6 oz 7.44 kg	15 lb 9 oz 7.06 kg	6 lb 2.76 kg
Suitable for display sizes	All	50" – 60"	60"+	70"+	-	-	-	-	-	-
On-Wall Bracket	-	BSB	BSB	BSB	-	-	-	-	-	-

Category	Accessories (Back Boxes)					
Model Name	CCBOX-R	CCBOX-L	WCBOX-L	CMBOX-R	PLIC-BOX II	IWB-10
Page	40	40	40	40	41 (23)	41 (31)
Overall Dimensions (H x W x D)	13 x 13 x 4 <sup>15/16</sup> " 330 x 330 x 125 mm	13 x 13 x 6 <sup>1/2</sup> " 330 x 330 x 165 mm	23 <sup>1/2</sup> x 17 <sup>1/8</sup> x 4 <sup>3/4</sup> " 590 x 435 x 120 mm	11 <sup>13/16</sup> x 13 <sup>3/4</sup> x 6 <sup>5/16</sup> " 300 x 350 x 160 mm	7 <sup>1/2</sup> x 24 <sup>3/4</sup> x 13 <sup>3/4</sup> " (Inc. Brackets) 191.2 x 628.6 x 350 mm	33 <sup>1/2</sup> x 13 <sup>3/16</sup> x 3 <sup>11/16</sup> " 850 x 351 x 85 mm
Internal Volume	6.31 L	8.9 L	14.8 L	12.2 L	24 L	16.5 L

# HOME THEATRE SYSTEMS

## In-Ceiling 5.1 Home Theatre

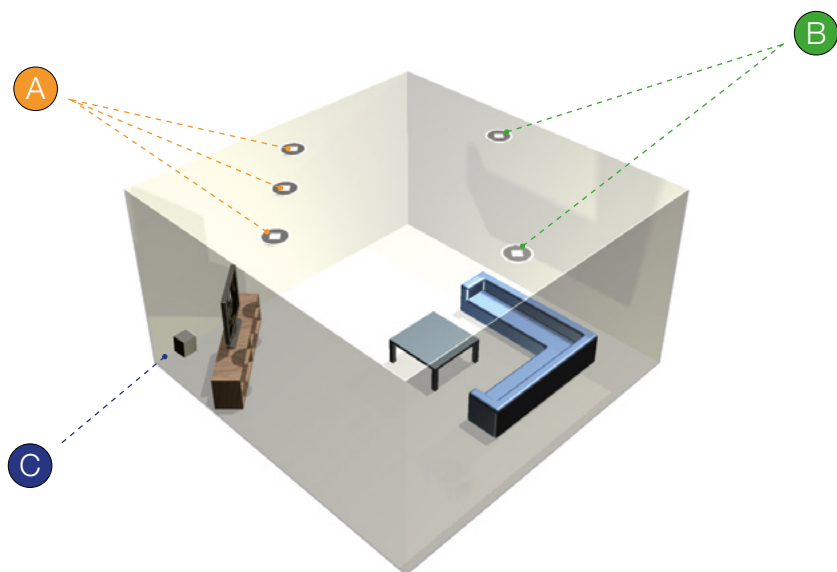

Our Custom Install speakers and accessories can be used to create an amazing Home Theatre system using either In-Ceiling or In-Wall or a combination of both. There are a number of optimum layouts and positions that will enhance your sound and listening pleasure.

All our Custom Install products can be used in conjunction with our traditional speaker ranges. To find out more about our speaker ranges please visit [monitoraudio.com](http://monitoraudio.com)



Platinum II



Silver 6G

## In-Wall 7.1 Home Theatre

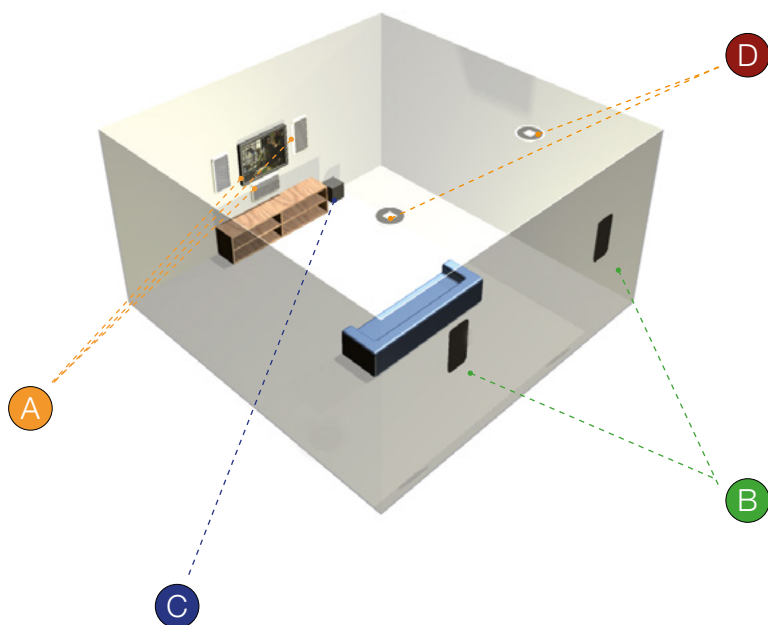

- A** Front Left-Centre-Right main loudspeakers
- B** Rear Left-Right surround loudspeakers
- C** Add your choice of Monitor Audio subwoofer to complete the theatre
- D** You can use In-Wall front IDC loudspeakers with In-Ceiling Left-Right surrounds if desired

# Find out more about Monitor Audio **Custom Install**



## Visit

[monitoraudio.com](http://monitoraudio.com) for product information, to find your local dealer and to sign up for our newsletter.



## Download

our **Custom Install INSIDER** magazine from our website or pick one up at your local dealer.



## Share

your custom installation with us on [Facebook](#), [Twitter](#) and [Instagram](#) for a chance to be in our next issue of INSIDER magazine  
[@monitoraudio](#) [#monitoraudio](#)





**Monitor Audio Ltd**  
24 Brook Road, Rayleigh,  
Essex, SS6 7XJ England  
T. + 44 (0)1268 740580  
F. + 44 (0)1268 740589  
E. [info@monitoraudio.com](mailto:info@monitoraudio.com)  
[monitoraudio.com](http://monitoraudio.com)